



Electric Screwdriver General Catalog 22A

innovative technology
for Turning The World

HIOS®



HIOS[®]



Since its establishment in 1970, HIOS has researched and developed a series of systems related to fastening technologies including screws, electric screwdrivers, and torque measuring instruments, and has manufactured and provided products that are one step ahead of the market. We will continue to take on new challenges without being bound by conventional ways of thinking in order to achieve the world's best quality.



HIOS PRODUCTS

DC Type

Electric Screwdrivers

Brushless Screwdrivers

Supports Precision Assembly
Standard/Built-in Pulse System
BLG Series P.9



Supports precision Assembly
Built-in Torque Sensor
PG Series P.15



Brushed Screwdrivers

Supports Precision Assembly
Standard
CL Series P.19



Supports Speedy Production by Pressure
Screw Feeding
Reciprocating
RN53 Series P.37



Supports Precision Assembly
Standard
BL Series P.17



Supports Automation of Assembly Lines
For Automated Machines
PGF/BLF Series P.31-33



Supports Precision Assembly
For Automated Machines
CLF / αF / CL-A Series P.35



AC Type

Electric Screwdrivers

Brushless Screwdrivers

Supports Heavy-duty Operations
Standard
VB Series P.23



Supports Ultra-high Torque Fastening
Hammer-head
VBH Series P.23



Brushed Screwdrivers

Supports Heavy-duty Operations
Standard
VZ Series P.27



Supports Ultra-high Torque Fastening
Hammer Head
VZH Series P.27



Related Products

Power Supplies for DC Screwdrivers

P.21



- Power Supply for Manual Screwdriver
- Controller for Automatic Screwdriver

Peripherals

P.39



- Cord
- Vacuum Pump
- Handgrip for Manual Screwdriver
- Grip Ring
- Carbon Brush
- Stand for Vertical Operation
- Relay Box

Screw Counters

P.41



Screw Counters

- STC3 Series
- STC Series

Separate Counters

- SC1 Series

Torque Meters

P.43



- HDP Series
- HP Series
- HM Series
- HIT Series

Automatic Screw Feeders

P.47



For Manual/Automatic Screwdrivers

- HSV Series / HSV-RB Series
- HS Series / HS-RB Series
- HSIII Series / HSIII-RB Series
- HSF Series

Bits/Accessories for Suction Screwdrivers

P.51



Suction Attachments

Spare Bits for Electric Screwdrivers Mouthpiece

DC Type

Power Tools

Brushless

Supports tapping of pilot holes

Electric Tappers

BL-SB Series

P.49



Brushed

Supports tapping of pilot holes

Electric Tappers

SB Series

P.49



Certification

List of Certified Products

P.55

- European Safety Standards (CE)
- China Quality Certification (CQC)
- China Compulsory Certification (CCC)
- US and Canadian Safety Standards (UL/cUL)
- ESD Control (IEC 61340)
- Electro-Static Discharge (ESD)
- RoHS
- China RoHS

Table of Contents

DC Screwdrivers

AC Screwdrivers

Screwdrivers for Automated Machines

Recipro Screwdrivers

Related Products

International Standard Certifications

Order Codes

Features of Electric Screwdrivers.....	5
Selection Chart of Electric Screwdrivers.....	7

DC Screwdrivers

BLG-BC2 Series	9
BLG-ZERO1 Series.....	13
BLG-BC1 Series	13
BLG Series.....	13
PG Series.....	15
BL Series.....	17
CL Series.....	19
Electric Tappers	
BL-SB Series	49
SB Series.....	49

AC Screwdrivers

VB Series	23
VZ Series	27

Screwdrivers for Automated Machines

PGF Series.....	31
BLF Series	33
CLF Series.....	35
aF Series.....	35
CL-A Series	36

Recipro Screwdrivers

RN53 Series.....	37
------------------	----

Related Products

Power Supplies/Controllers	21
Peripherals	39
Screw Counters	
STC3 Series.....	41
STC Series	41
SC1 Series.....	41
Torque Meters	
HDP Series.....	43
HP Series.....	44
HM Series.....	45
HIT Series.....	46

Automatic Screw Feeder

HS Series	47
Accessories for Standard Suction Screwdrivers.....	51
Accessories for Standard Suction Machines	53
Electric Screwdriver Bit for Exchange.....	57
Electric Screwdriver Bit for Exchange (Hexalobular).....	59
Electric Screwdriver Bit for Exchange (TORX® & TORX PLUS®).....	60

International Standard Certifications

International Standard Certifications.....	55
--	----

Order Codes

Order Codes.....	61
------------------	----

FEATURES OF ELECTRIC

Features of Electric Screwdriver



1 Detachable Cord (DC Type)

The cord is detachable with the connector. This makes maintenance easy. (AC-type cords are not detachable.)



2 Start (ST) Types

- Lever start: trigger the lever on the unit with your finger to start.
- Push-to-start: push the screwdriver gently to start.
- Push and Lever: you can select either Lever start or Push-to-start.

3 Torque Adjustment Nut That Can be Fine Tuned

The fastening torque range is wide, and stepless adjustment is possible. In addition, since the repetitive torque accuracy is high, screws can be accurately and stably fastened.

4 Brushless Motor (for Brushless Screwdrivers)

Since a carbon brush is not used, carbon particles are not generated, and the torque accuracy and durability of the screwdriver are greatly improved. Stable quality control can be achieved.

5 External Carbon Brush (for Brushed Screwdrivers)

The design of external carbon brush facilitates its easy replacement. The carbon brush can endure about one million screw fastening*.

*This may vary depending on usage conditions.

SCREWDRIVERS

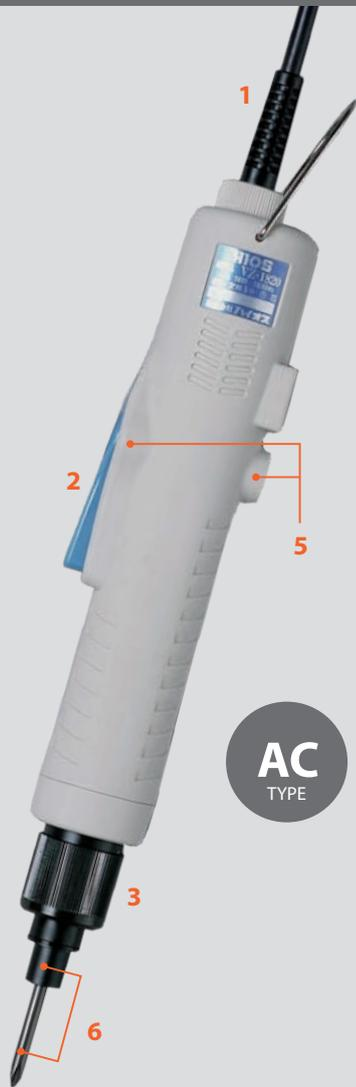

AC
TYPE

DC Type Low Voltage DC

Driven in combination with a low voltage DC power unit.



AC Type Without Transformer

Driven by direct connection with AC power source.



Icon Guide



Anti-electrostatic body case
(Surface resistance: less than $3 \times 10^{12}\Omega$)

Anti-electrostatic resin is employed for the body case of the screwdriver to prevent the generation of static electricity. This makes the screwdriver suitable for assembly of precision equipment and electronic parts.



Anti-electrostatic
IEC61340 certified.

VARIATION

Suction

Q



Suction Part
(Optional Item)

It sucks up screws with negative pressure and you don't have to pick up screws. It also sucks up non-ferrous screws such as plastic ones. In addition, dust generated during screw fastening can be removed.

For Clean Room / Anti-electrostatic

Q-CR-ESD



Electrostatic proof. Two vacuum units on the main body and the suction part make sure to suck up dust generated during screw fastening.

[Equivalent to Class 100]
[Surface resistance: less than $10^9\Omega$]

Anti-electrostatic

ESD



An anti-electrostatic resin is employed for the body case through the switch lever. It protects components from static electricity.

[Surface resistance: $10^9\Omega$ or smaller]

Supporting Screw Counter

OPC



Can be connected to the screw counter to prevent screw fastening skipping. The screwdriver is featured with clockwise / counterclockwise rotation and torque-up (completion) signal outputs.



Noiseless

NL



Electrostatic noises can be reduced better than standard products.

6 Bits

There are three drive types: HIOS Shank, Two-way Shank, and HEX Shank. Please specify your desired bit drive type from the order code.

•For HIOS Shank type, please use the HIOS bit. See [P.57](#)

•For HEX Shank type, please purchase commercially available bits.

Drive	HIOS Shank Type (H4 or H5)		Two-way Type (H5 and 5HEX)	
	H4	H5	H5	5HEX (commercially available)
Type				
Standard	$\varnothing 4$	$\varnothing 5$	$\varnothing 5$	$\varnothing 5 \times \rightarrow 14.0$
Drive	HEX Shank Type			
	Obtain commercially available bits matching with the specified dimensions.			
Type	1/4HEX (Commercially Available)	5HEX (Commercially Available)		
Special Order				
	$6.35 \times \rightarrow 19.0$	$5 \times \rightarrow 14.0$		

Unit: mm

Selection Chart of Electric Screwdrivers

Please use this chart as a guide for model selection.

Screwdriver classification	Model	Output Torque Range										Unloaded Rotation Speed (r.p.m) (HI/LOW)	Guide for Screw Size (mm)		Applications	
		N·m											Machine Screw	Tapping Screw		
		0.05	0.2	0.4	0.6	0.8	1	1.2	1.4	1.6	1.8					2
BC2 / BC1 / ZERO 1 / BLG Series	Standard	0.1-0.55										1,000 / 690	1.4-2.6	1.4-2.3	Cell phones, watches, cameras, TVs, glasses, optical pickups, PCs, HDD players, CD players, car navigation systems, car audio systems, air conditioners, fan heaters, etc.	
	BLG-4000 Series	0.1-0.55											1.0-2.3	1.0-2.0		
	BLG-4000BC2-LT	0.03-0.2										1,000 / 690	2.0-3.0	2.0-3.0		
	BLG-5000 Series	0.2-1.2										1,500 / 1,000	2.3-3.0	2.0-2.6		
	HI Speed	BLG-5000-15 Series	0.3-1										1,800 / 1,200	2.3-3.0		2.0-2.6
	HI Torque	BLG-5000-18 Series	0.5-1.5										730 / —	2.0-4.0		2.0-3.0
	BLG-5000-HT Series	0.5-2										1,200 / 800	2.6-5.0	2.6-4.0		
PG Series	Standard	0.2-0.55										980 / 680	1.7-2.3	2.0-2.3	Electric components, automobile components, pneumatic components, etc.	
	PG-3000	0.2-0.55										900 / 590	2.3-3.0	2.0-2.3		
	PG-5000	0.4-1.2										960 / 630	2.6-5.0	2.6-4.0		
BL Series	Standard	0.02-0.2										990 / 650	1.0-2.3	1.0-2.0	Cell phones, watches, cameras, glasses, hard discs, CD players, optical pickups, car navigation systems, car audio systems, video cameras, compact calculators, etc.	
	BL-2000	0.02-0.2											1.0-2.3	1.0-2.0		
	BL-2000SS*	0.02-0.2										980 / 680	1.7-2.3	2.0-2.3		
	BL-3000	0.2-0.55										900 / 590	1.7-2.3	2.0-2.3		
	BL-3000SS*	0.2-0.35										900 / 590	2.0-3.0	2.0-3.0		
	BL-5000	0.2-1.2										2.0-3.0	2.0-3.0			
	BL-5000SS*	0.2-1.2										1,500 / 1,000	2.0-3.0	2.0-2.6		
	HI Speed	BL-5000-15	0.3-1.0										750 / 500	2.0-4.0		2.0-3.0
	HI Torque	BL-5020	0.5-2										960 / 630	2.6-5.0		2.6-4.0
	Standard	BL-7000	0.7-2.8													
CL Series	Standard	0.02-0.2										680 / 490	1.0-2.3	1.0-2.0	Automobile components, PCs, printers, TVs, air conditioners, fan heaters, video game consoles, facsimiles, communication devices, copy machines, scanners, satellite antennas, video recorders, door mirrors, toys, electronic thermometers, etc.	
	CL-2000	0.02-0.2										1,000 / 670	1.0-2.0	1.0-1.7		
	CL-3000	0.03-0.2										1,000 / 690	1.4-2.6	1.4-2.3		
	CL-4000	0.1-0.55										800 / 500	2.0-3.0	2.0-2.6		
	CL-6000	0.2-1										900 / 600	2.0-4.0	2.0-3.0		
	CL-6500	0.3-1.6										750 / —	2.0-5.0	2.0-4.0		
	CL-7000	0.3-2.5										530	4.0-6.0	4.0-6.0		
HI Torque	CL-9000	1.2-5														
VB Series	Standard	0.25-1.5										970	2.0-4.0	2.0-3.0	Lighting equipment, washing machines, vacuum cleaners, gas equipment, microwaves, door mirrors, electric automobile components, rear lamps, headlights, video game consoles, copy machines, communication devices, pneumatic components, electric tools, etc.	
	VB-1510	0.25-1.5										1,800	2.0-4.0	2.0-3.0		
	HI Speed	VB-1510-18	0.2-1										2,000	2.6-4.0		2.6-3.0
	Standard	VB-1820	0.4-1.8										800	2.0-4.0		2.0-3.0
	HI Torque	VB-2008	0.4-2										1,200	3.0-5.0		3.0-4.0
	Standard	VB-3012	0.5-3										2,000	3.0-5.0		3.0-4.0
	HI Torque / HI Speed	VB-3020	1-3										400	3.0-5.0		3.0-4.0
	Standard	VB-4504	1-4.5													
	Ultra HI Torque	VBH-1820PS	3-7										470	5.0-6.0		5.0-6.0
VBH-3012PS	4-10										270	5.0-6.0	5.0-6.0			

BLG-BC2 Series (DC Type)

Real-time error detection helps anyone becoming a Skilled Craftperson.

IoT realizes the visualization of screw fastening.

Screw fastening errors that are difficult to detect visually can be detected in real time.

The pulse system that judges if a screw is fastened correctly or not can detect various screw fastening errors. It detects “abnormal” conditions to prevent serious problems without depending on workers’ proficiency.

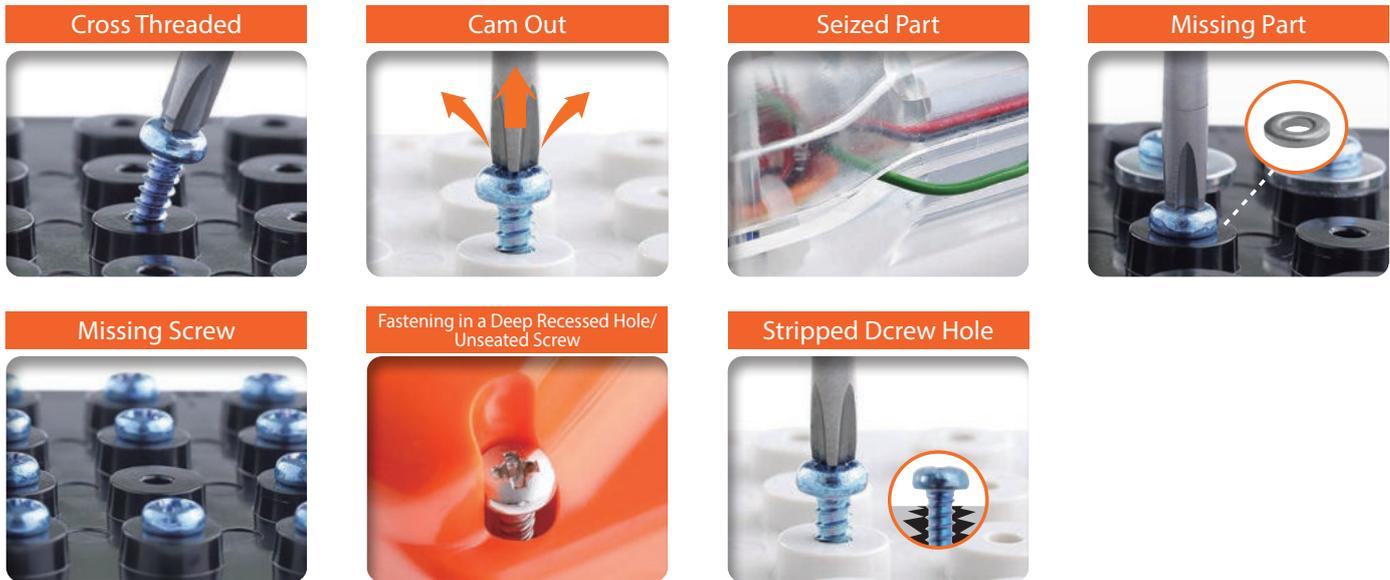

Prevent mixing of Wrong Screws!



BLG-IO-Pro1 [Example of connection with external devices]

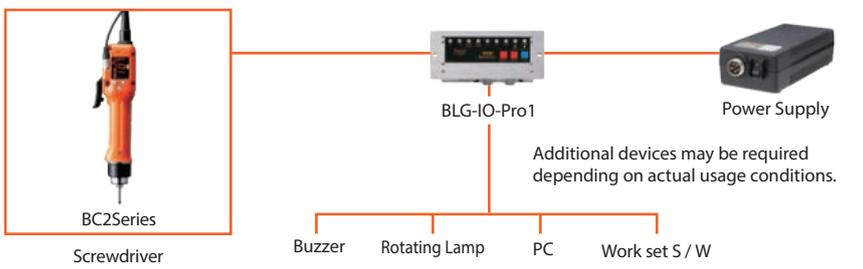

RELATED PRODUCTS

External I/O Box
BLG-IO-Pro1

By connecting this box to the screwdriver, you can control screw fastening easily such as error detection.

* Please separately purchase an external I / O cable.

DC Screwdrivers | Brushless Screwdrivers BLG-BC2 Series

JUKUREN × IoT System



This extension unit of BLG-BC2 collects screw fastening data on the cloud and manages it in one stop. You can manage the production status of multiple sites in real time for analysis and preventing problems.

The Data I/O Port Improves Production Management Efficiency

You can change settings from PC or PLC. Traceability is also supported with fastening data output.



Built-in Pulse System (PAT.)

Automatically counts the number of rotating pulses of the motor. Screw fastening errors are detected with high accuracy in real time.

Brushless Motor

Because carbon particles are not generated, it is environmentally friendly with improved durability and stability.

Direct Teaching

When it fastens few screws on a workpiece, it automatically detects the number of rotating pulses from the start to seating.

Display Panel to Check Measured Value

The measured value is displayed on the panel at hand after each fastening. The screwdriver judges OK / NG to reduce workload.

Screw Counter

The number of screws for fastening can be set from 1 to 99. It reminds you about the number of remaining screws through counting down.

BLGIF2 [Image of linkage with external devices]



BC2Series
Screwdriver



Pattern	No of screws / rotations
1 ▶	2 screws, 150 rotations
2 ▶	3 screws, 130 rotations
3 ▶	2 screws, 130 rotations
4 ▶	1 screw, 120 rotations



BLG-IF2

RELATED PRODUCTS

Serial-to-parallel Conversion Box

BLG-IF2

The communication mode with an external device such as a PLC can be converted from serial to parallel. Up to 4 setting patterns including the number of screws and pulses can be saved and switched on the PLC.



BLG-BC2 Series (DC Type)



BLG-4000BC2



Lever

Low Torque
BLG-4000BC2-LT



Lever

BLG-5000BC2



HI Speed
BLG-5000BC2-15
BLG-5000BC2-18
HI Torque
BLG-5000BC2-HT



Push and Lever

SPECIFICATIONS

Start type		Lever		Push and Lever				
Model		BLG-4000BC2	BLG-4000BC2-LT	BLG-5000BC2	BLG-5000BC2-15	BLG-5000BC2-18	BLG-5000BC2-HT	BLG-7000BC2
Output torque range (N·m)		0.1 - 0.55	0.03 - 0.2	0.2 - 1.2	0.3 - 1.0	0.5 - 1.5	0.5 - 2.0	0.7 - 2.8
Unloaded rotation speed (r.p.m.)±10% [HI / LOW]		1,000 / 690		1,000 / 690	1,500 / 1,000	1,800 / 1,200	730 / —	1,200 / 800
Screw size (mm)	Machine screw	1.4 - 2.6	1.0 - 2.3	2.0 - 3.0	2.3 - 3.0	2.3 - 3.0	2.0 - 4.0	2.6 - 5.0
	Tapping screw	1.4 - 2.3	1.0 - 2.0	2.0 - 3.0	2.0 - 2.6	2.0 - 2.6	2.0 - 3.0	2.6 - 4.0
Outer dimensions	Grip diameter (Max)	ø32.7		ø38		ø38		ø40
	Length (mm)	206	207	235		235		238
Weight (g)		370	312	425		425		670
Power supply	T-45BL	○	○	○	○★	—	○★	—
	T-70BL	○	○	○	○★	○★	○★	○★
	T-80BL	○	○	○	○★	○★	○★	○★
Bit drive selection	Standard	H4		H4		H5 and 5HEX (compatible)		
	Special Order	1/4HEX	—	H5 and 5HEX (compatible) or 1/4HEX		1/4HEX		
Accessories	Bit (one each)	H4	+ #0 (ø2.5×40) + #1 (ø4.0×40)	+ #0 (ø2.0×40) + #0 (ø2.5×40)	+ #1 (ø4.0×40) + #2 (ø4.0×40)		—	
		H5	—		+ #1 (ø5.0×60) + #2 (ø5.0×60)		+ #1 (ø5.0×60) + #2 (ø5.0×60)	
	HEX Shank	1/4HEX	+ #1 (ø5.0×50) + #2 (ø5.0×50) - (ø5.0×50)	—	—		+ #1 (ø5.0×50) + #2 (ø5.0×50) - (ø5.0×50)	
Torque adjustment spring		White	Yellow	—		—		
Cord length		2m (6P)		2m (6P)		2m (6P)		
L-shaped HEX wrench		—		Width across flat: 5mm, 1 pc		Width across flat: 5mm, 1 pc		
Variations	BLGQ	H4	●	●		●		
		HEX Shank	—	—		—		

● For the models with the ★ mark, use with output power HI (DC 30V). With LOW (DC 20V) output, the screwdriver features may not be fully performed.

Power supply [P.21](#) → Spec. [P.55](#) →

HI Torque
BLG-7000BC2
BLG-7000BC2-GT



A range of torque types, from low to high, applicable to various production lines

Main features

- Error detection (number of rotations)
- Direct teaching
- Screw fastening count (1 to 99)
- Error warning (sound and lamp)
- Data I/O port (RS232C)
- Count error prevention (for retightening)
- Reverse rotation count up
- Maintenance reminder (accumulated total count)



Push and Lever

BLG-7000BC2-GT Coming Soon

Grip Type

Stand Type

Maximum Torque: 5N·m

Output Torque Guide (HI Input) ❖

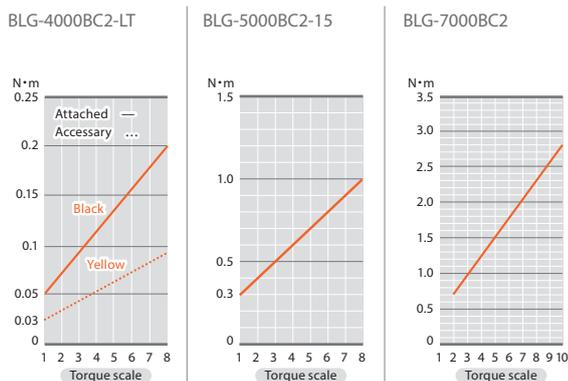
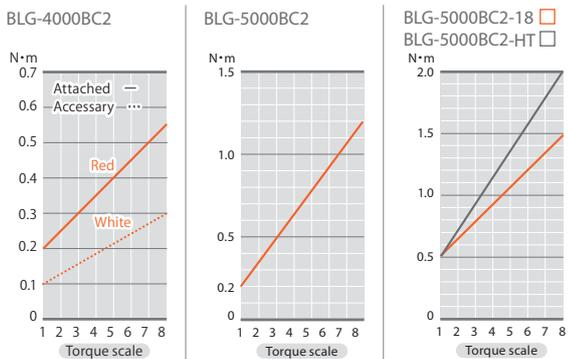

❖ For some models, two torque adjustment springs, for HI torque (installed) and for LOW torque (accessory), are included. Please use a suitable one for your operation.

APPLICABLE DRIVERS

Suction

BLGQ



POWER SUPPLY

T-45BL

T-70BL

T-80BL



See [P.21](#) →

See [P.21](#) →

See [P.21](#) →

ACCESSORIES

Stand for Vertical Operations

VMS-40 / VMS-50

Keeps the screwdriver in a vertical position, allowing accurate screw fastening.

Applicable models:
 BLG-4000BC2
 BLG-5000BC2 Series

See [P.40](#) →



Cord for External I/O

BLG-BC2-3012

The plug design has been renewed to enhance robustness by a one-touch lock.



BLG-ZERO1 熟練工 / BLG-BC1 /

Screw Counter / Pulse System

BLG-ZERO1 Series 熟練工



Even a beginner can be a skilled craftsman in only 30 seconds. The direct teaching function automatically learns correct fastening just by fastening a few screws into a workpiece. Also fastening errors are detected in real time.

Main features

- Error detection (No. of rotations)
- Direct teaching
- Screw fastening count (1 to 99)
- Error warning (sound and lamp)

4000 Series



Lever

5000 Series



Push and Lever

With Screw Counter Built-in

BLG-BC1 Series



It supports correct fastening by measuring the time until seating. The built-in counter can prevent human errors in operations.

Main features

- Error detection (time)
- Counter ON / OFF
- Screw fastening count (1 to 99)
- Error warning (sound and lamp)
- Count error prevention (for check fastening, double fastening and retightening)

4000 Series



Lever

5000 Series



Push and Lever

SPECIFICATIONS

Start type		Lever	Push and Lever			
BLG-ZERO1 Series		BLG-4000ZERO1	BLG-5000ZERO1	BLG-5000ZERO1-15	BLG-5000ZERO1-18	BLG-5000ZERO1-HT
BLG-BC1 Series		BLG-4000BC1	BLG-5000BC1	BLG-5000BC1-15	BLG-5000BC1-18	BLG-5000BC1-HT
BLG Series		BLG-4000	BLG-5000	BLG-5000-15	BLG-5000-18	BLG-5000-HT
Output torque range (N·m)		0.1 - 0.55	0.2 - 1.2	0.3 - 1.0	0.5 - 1.5	0.5 - 2.0
Unloaded rotation speed (r.p.m)±10% [HI / LOW]		1,000 / 690	1,000 / 690	1,500 / 1,000	1,800 / 1,200	730 / —
Screw size (mm)	Machine screw	1.4 - 2.6	2.0 - 3.0	2.3 - 3.0		2.0 - 4.0
	Tapping screw	1.4 - 2.3	2.0 - 3.0	2.0 - 2.6		2.0 - 3.0
Outer dimensions	Grip diameter (Max)	∅32.7	∅38		∅38	
	Length (mm)	206	235		235	
Weight (g)		370	425		425	
Power supply	T-45BL	○	○	○★	—	○★
	T-70BL	○	○	○★	○★	○★
Bit drive selection	Standard	H4	H4		H5 and 5HEX (compatible)	
	Special Order	1/4HEX	H5 and 5HEX (compatible) or 1/4HEX		1/4HEX	
Accessories	Bit (one each)	H4	+#1 (∅4.0×40) +#2 (∅4.0×40)		—	
		H5	—		+#1 (∅5.0×60) +#2 (∅5.0×60)	
	HEX Shank	1/4HEX	+#1 (∅5.0×50) +#2 (∅5.0×50) - (∅5.0×50)		—	
Torque adjustment spring		White	—		—	
Cord length		2m (6P)	2m (6P)		2m (6P)	
L-shaped HEX wrench		—	Width across flat: 5mm, 1 pc		Width across flat: 5mm, 1 pc	
Variations	BLGQ	HIOS Shank	●	●	●	●
	BLG-OPC (BLG Series only)	HEX Shank	—	—	—	—
●(BLG-ZERO1 and BC1 have the screw counter built-in.)						

● For the models with the ★ mark, use with output power HI (DC 30V). With LOW (DC 20V) output, the screwdriver features may not be fully performed.

Power supply **P.21** Spec. **P.55**

BLG Series (DC Type)

BLG

Standard

BLG Series



Brushless version of our long-seller CL Series. Improved durability contributes to stable screw fastening quality. With an easy-to-handle compact body, it achieves excellent cost performance.

The orange body is a symbol of the trustworthiness of HIOS. The BLG Series has a rich lineup from which you can choose one based on the function most suitable for your operation.

4000 Series



Lever

5000 Series



Push and Lever

RELATED PRODUCTS BLG Series

Relay Box for Completion Signal

BLOP-AF

The signal from the screwdriver can be used by an external device via this box.



See [P.40](#)

Relay Box for I/O Signal

BLOP-OST2

The signal from the screwdriver can be relayed to an external device via this box. Switching ON / OFF the power is also possible.



See [P.40](#)

Output Torque Guide (HI Input) ❖

BLG-4000 Series

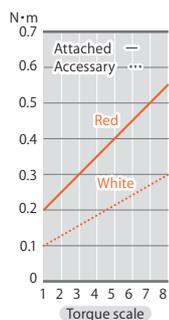

BLG-5000-15 Series

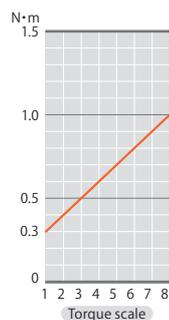

BLG-5000-HT Series

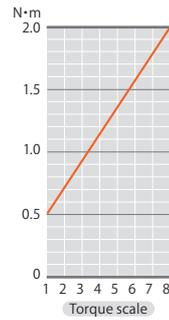

BLG-5000 Series

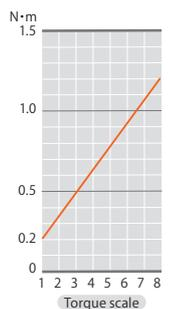

BLG-5000-18 Series

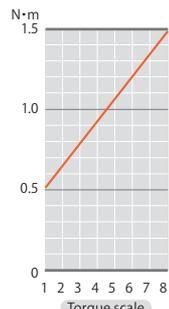

*The colors in the chart indicate the spring colors.

❖For some models, two torque adjustment springs, for HI torque (installed) and for LOW torque (accessory), are included. Please use a suitable one for your operation.

APPLICABLE DRIVERS Variations

Suction

BLGQ



See [P.51](#)

Suction Part
(Optional Item)

Supporting Screw Counter

BLG-OPC



See [P.41](#)

Counter

POWER SUPPLY

T-45BL



See [P.21](#)

T-70BL



See [P.21](#)

ACCESSORIES

Stand for Vertical Operations

VMS-40 / VMS-50

The stand keeps the screwdriver in a vertical position, allowing accurate screw fastening.



See [P.40](#)

PG Series (DC Type)

PG-3000



PG-5000



PG-7000



Lever



Lever



Lever

SPECIFICATIONS

Model		PG-3000	PG-5000	PG-7000	
Output torque range (N·m)		0.2 - 0.55	0.4 - 1.2	1.0 - 2.8	
Unloaded rotation speed (r.p.m) ±10% [HI / LOW]		980 / 680	900 / 590	960 / 630	
Screw size (mm)	Machine screw	1.7 - 2.3	2.3 - 3.0	2.6 - 5.0	
	Tapping screw	2.0 - 2.3	2.0 - 2.3	2.6 - 4.0	
Outer dimensions	Grip diameter (Max)	∅32.5	∅33	∅39	
	Length (mm)	245	260	298	
Weight (g)		345	509	807	
Power supply		T-70BL ○	○	○	
Bit drive selection	Standard	H4		H5 and 5HEX (compatible)	
	Special Order	—		1/4HEX	
Accessories	Bit (one each)	H4	+ #0 (∅2.5×40), + #1 (∅4.0×40), + #2 (∅4.0×40)		
		H5	—		
		HEX Shank	1/4HEX		
Cord length		2m (6P)			
Sensor cord (m)		1.7m (8P)			
Others		CD-ROM of Software, RS232C cable 1 piece, USB-serial conversion cable 1 piece, AC adaptor (for AC100-240V) 1 piece			
Variations	PGQ	HIOS Shank	●	●	●
		HEX Shank	—	—	—

Power supply [P.21](#) [Spec. P.55](#)

PPG-01 I / O Connector / Output (open collector)

I/O	Shared by plus COM and minus COM, Output: Sink type	
Connector	Male connector	(Part No.: Hirose HIF3BA-20PA-2.54DS)
	External connector	(Part No.: Hirose HIF3BA-20D-2.54R)
Type	Minus COM (Supporting NPN) *Plus COM PNP is not applicable.	

* An external connector is not included. Please prepare it by yourself.

Output Torque Guide (HI Input)

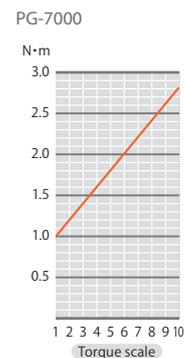
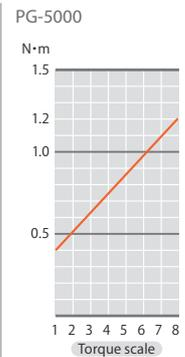
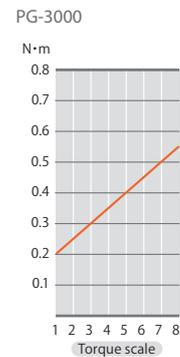

Workflow of Pass Guard System Use

Setting the reference values for OK / NG criteria

- Memorizing acceptance criteria (teaching)
- The acceptance criteria are determined by conducting an actual fastening procedure. The minimum and the maximum values of fastening torque and work time are then saved.
- Set the acceptable range (error rate setting)
- The acceptable range for the minimum and maximum values of fastening torque and work time can be selected from 0, 2, 5, 10, 15 and 20%.

Actual operation

Every screw fastening is inspected in real time.

Judgement

OK / NG results are indicated by LED light and buzzer of PG-01.

Record and save the data with a PC

The measurement data can be checked and recorded by using the bundled software.

OK / NG Criteria

NG (L. NG)	Acceptable range (L. G.)	GOOD	Acceptable range (H. G.)	NG (H. NG)
Lower than L. G. value.	Within the specified % from the Good lower limit value.	Between the Good lower and upper limit values.	Within the specified % from the Good upper limit value.	Higher than H. G. value.



Judging screw fastening quality and saving the data. For error detection, you can rely on the Pass Guard System

- The built-in torque sensor automatically judges every fastening (OK / NG).
- The errors that are difficult to be found visually (such as insufficient torque, unseated or cross threaded) can be detected automatically.
- All the operation data can be saved by connecting PG-01 to an external device.

Configuration

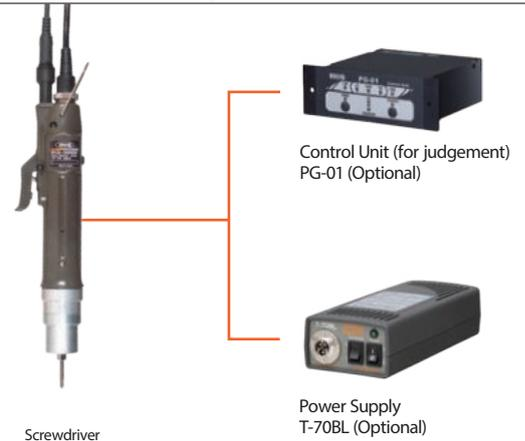

Screwdriver

Power Supply T-70BL (Optional)

Saving Data with Software

By using the bundled software, you can check the OK / NG judgment of screw fastening and save the measurement data in real time.

Data Import Sheet / EXCEL

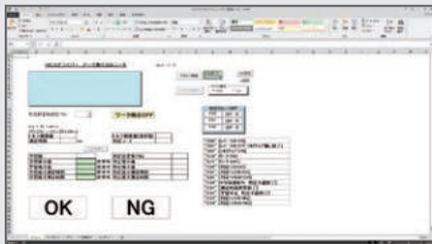

Screwdriver Data Collection / Application



APPLICABLE DRIVERS

Variation

Suction

PGQ



Suction Part (Optional Item)

See [P.51](#)

RELATED PRODUCTS

Control Unit (for judgement)

PG-01 (optional)

Reads the signals from the screwdriver to decide OK / NG in real time.

- Standard: RS-232C
- Input voltage: AC100-240V (50/60Hz)
- Outer dimensions: W149×D120×H49
- Weight: 520g



POWER SUPPLY

T-70BL



See [P.21](#)

BL Series (DC Type)

BL-2000

Shock Absorbing

BL-2000SS



Side view



Lever

BL-3000

Shock Absorbing

BL-3000SS



Push and Lever



BL-5000

Shock Absorbing

BL-5000SS

HI Speed

BL-5000-15

HI Torque

BL-5020



Push and Lever



SPECIFICATIONS

Lever start model		BL-2000 BL-2000SS	—	—	—	—	—
Push and Lever		—	BL-3000 BL-3000SS	BL-5000 BL-5000SS	BL-5000-15	BL-5020	BL-7000
Output torque range (N·m)		0.02 - 0.2	0.2-0.55 0.2-0.35 (SS)	0.2 - 1.2	0.3 - 1.0	0.5 - 2.0	0.7 - 2.8
Unloaded rotation speed (r.p.m)±10% [HI / LOW]		990 / 650	980 / 680	900 / 590	1,500 / 1,000	750 / 500	960 / 630
Screw size (mm)	Machine screw	1.0 - 2.3	1.7 - 2.3	2.0 - 3.0		2.0 - 4.0	2.6 - 5.0
	Tapping screw	1.0 - 2.0	2.0 - 2.3	2.0 - 3.0	2.0 - 2.6	2.0 - 3.0	2.6 - 4.0
Outer dimensions	Grip diameter (Max)	∅26	∅32.5	∅38	∅38	∅38	∅40
	Length (mm)	172	192	207	207	207	239
Weight (g)		254	320	360	360	360	640
Power supply	T-45BL	○	○	○	○★	○★	—
	T-70BL	○	○	○	○★	○★	○
Bit drive selection	Standard	H4		H4		H5 and 5HEX (compatible)	
	Special Order	—	1/4HEX	H5 and 5HEX (compatible) or 1/4HEX		1/4HEX	
Accessories	Bit (one each)	HIOS Shank	H4 +#0 (∅2.0×40) +#0 (∅2.5×40)	+#0 (∅2.5×40) +#1 (∅4.0×40)		+#1 (∅4.0×40) +#2 (∅4.0×40)	
		H5	—		+#1 (∅5.0×60) +#2 (∅5.0×60)		+#1 (∅5.0×60) +#2 (∅5.0×60)
	HEX Shank	1/4HEX	+#1 (∅5.0×50), #2 (∅5.0×50) - (∅5.0×50)				
Torque adjustment spring		Yellow	—	—		—	
Cord length		2m (5P) ESD	1.5m (5P)	1.5m (5P)		1.5m (5P)	2m (5P)
L-shaped HEX wrench		—		Width across flat: 5mm, 1 pc		Width across flat: 5mm, 1 pc	
Variations	BLQ	HIOS Shank	●	●	●	●	●
		HEX Shank	—	—	—	—	—
	BLQ-ESD		Anti-electrostatic	●	●	●	●
	BLQ-CR		●	●	●	●	●
	BL-ESD		Anti-electrostatic	●	●	●	●
	BLQ-CR-ESD		●	●	●	●	●
BL-OPC		●	●	●	●	●	

For the models with the ★ mark, use with output power HI (DC 30V). With LOW (DC 20V) output, the screwdriver features may not be fully performed.

Power supply [P.21](#) Spec. [P.55](#)

BL-7000



Employs an ultra-strong brushless motor that improves durability and stability

- Maintains a clean environment with a brushless motor that does not generate carbon particles.
- The temperature increase of the motor is suppressed by about 30%. With improved durability, maintenance cost is significantly reduced.
- Both start types, push and lever, are available on one model (except BL-2000).



Push and Lever

RELATED PRODUCTS

Pistol Attachment

PAB-70

Can be converted to a pistol type. Optimal for horizontal fastening.



Applicable model:
BL-7000 Series

Relay Box for Completion Signal

BLOP-AF

Signal from the screwdriver can be used by an external device via this box.



See [P.40](#)

Relay Box for I/O Signal

BLOP-OST2

Signal from the screwdriver can be relayed to an external device via this box. Switching ON/OFF the power is also possible.



See [P.40](#)

Output Torque Guide (HI Input) ❖

BL-2000
BL-2000SS

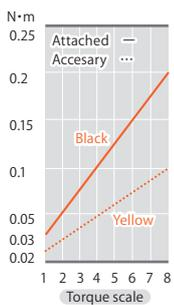

BL-3000
BL-3000SS

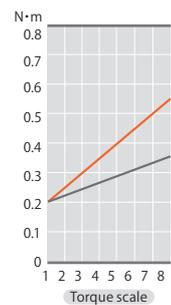

BL-5000
BL-5000SS

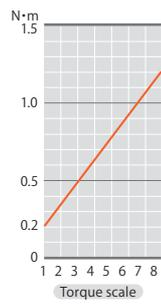

BL-5000-15

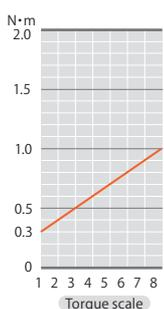

BL-5020

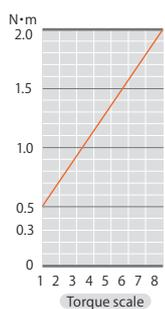

BL-7000

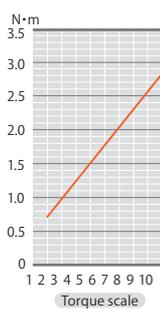

* The colors in the chart indicate the spring colors.

❖ For some models, two torque adjustment springs, for HI torque (installed) and for LOW torque (accessory), are included. Please use a suitable one for your operation.

APPLICABLE DRIVERS Variation

Suction

BLQ



Suction Part
(Optional Item)

See [P.51](#)

Suction/Anti-electrostatic

BLQ-ESD



For Clean Room

BLQ-CR



Anti-electrostatics

BL-ESD



For Clean Room /
Anti-electrostatics

BLQ-CR-ESD



Supporting Screw Counter

BL-OPC



See [P.41](#)

CL Series (DC Type)

CL-2000



Lever

CL-3000



Lever

CL-4000



Lever



Push

CL-6000



Lever

CL-6500



Push

SPECIFICATIONS

Lever start model		CL-2000	CL-3000	CL-4000	CL-6000	CL-6500	CL-7000	—
Push-to-start model		—	—	CL-4000PS	CL-6000PS	CL-6500PS	CL-7000PS	CL-9000
Output torque range (N·m)		0.02 - 0.2	0.03 - 0.2	0.1 - 0.55	0.2 - 1	0.3 - 1.6	0.3 - 2.5	1.2 - 5
Unloaded rotation speed (r.p.m)±10% [HI / LOW]		680 / 490	1,000 / 670	1,000 / 690	800 / 500	900 / 600	750 / —	530
Screw size (mm)	Machine screw	1.0 - 2.3	1.0 - 2.0	1.4 - 2.6	2.0 - 3.0	2.0 - 4.0	2.0 - 5.0	4.0 - 6.0
	Tapping screw	1.0 - 2.0	1.0 - 1.7	1.4 - 2.3	2.0 - 2.6	2.0 - 3.0	2.0 - 4.0	4.0 - 6.0
Outer dimensions	Grip diameter (Max)	∅26	∅32.5	∅32.5 / ∅37.5 (PS)	∅37	∅37	∅37	∅52
	Length (mm)	166	183	197	220 / 221 (PS)	235 / 236 (PS)	255 / 256 (PS)	250
Weight (g)		200	350	380 / 430 (PS)	600	660	750	3,010 (total)
Power supply	CLT-45	○	○	○	○	○	—	CLT-80
	CLT-60	○	○	○	○	○	○	—
Bit drive selection	Standard	H4			H5			1/4HEX
	Special Order	—			1/4HEX or 5HEX		1/4HEX or 5HEX	
Accessories	Bit (one each)	HIOS Shank	H4	+ #0 (∅2.0×40) + #0 (∅2.5×40)	+ #0 (∅2.5×40) + #1 (∅4.0×40)	—		—
		H5	—			+ #1 (∅5×60) + #2 (∅5×60)		—
	HEX Shank	1/4HEX	—		+ #1 (∅5.0×50) + #2 (∅5.0×50) - (∅5.0×50)		+ #2 (7.0×100) + #3 (7.0×100)	
Torque adjustment spring		Yellow	Gold	Blue	—	White	Yellow	—
Cord length		1.5m (5P)			2m (5P)			2m (5P)
Carbon brush order code (Optional / 2 pcs per set)		—	A45-0420	CL4-0420	CL65-0490			CL9-0410
Variations	CLQ	HIOS Shank	●	●	●	●	●	—
		HEX Shank	—	—	—	—	—	—
	CL-ESD	●	●	●	●	●	●	—
	CLQ-CR-ESD	—	●	●	●	●	●	—
CL-NL	—	●	●	●	●	●	●	

Notes: ● The carbon brush for CL-2000 is enclosed in the motor and cannot be replaced. Although the life of the carbon brush depends on use conditions, as a guide, if you fasten about 6,000 screws a day, you need to replace the carbon brush 3 to 4 years after you start using it. Please contact a HIOS distributor for maintenance and repair.

Power supply [P.21](#) Spec. [P.55](#)

CL-7000



Lever

Push

CL-9000 (with Shockless Stand)



Push

A long seller with a wide range of torque and reliable operability

- A wide range of torque enables accurate fastening.
- Easy-to-hold small diameter grip reduces workload.
- Supports high torque screw fastening up to 5N·m (CL-9000).

RELATED PRODUCTS

Power Supply with Screw Counter

CLT-70STC3

With screw counter that prevents screw skipping by displaying remaining No. of screws.

See [P.41](#)



Separate Counter

CLOP-SC1

The counter can be used by connecting it to existing HIOS power supply.

See [P.41](#)



Output Torque Guide (HI Input) ❖

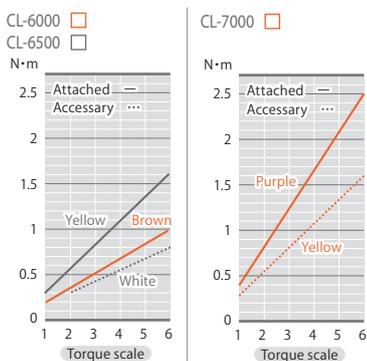
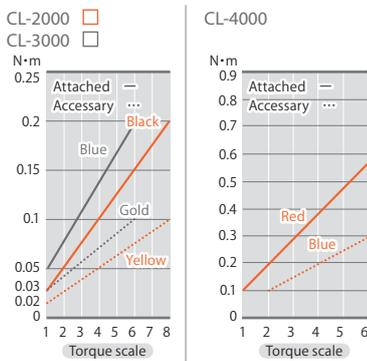

* The colors in the chart indicate the spring colors. CL-9000: For torque adjustment, refer to the torque scale sticker affixed to the main body.

❖ For some models, two torque adjustment springs, for HI torque (installed) and for LOW torque (accessory), are included. Please use a suitable one for your operation.

APPLICABLE DRIVERS Variations

Suction

CLQ



See [P.51](#)

Anti-electrostatic

CL-ESD



For Clean Room/Anti-electrostatic

CLQ-CR-ESD



See [P.51](#)

Noiseless

CL-NL



ACCESSORIES

Pistol Attachment

PA-65

Can be converted to a pistol type, which is optimal for horizontal fastening.



Applicable models: CL-6000, CL-6500, CL-7000 (including Push-to start type)

Angle Attachment

ANGL-Z (H5) ANGLX-Z (1/4HEX)

By attaching this to the tip, you can work smoothly in a narrow space.



Set the output to 1.2 N·m or smaller attachment.

Applicable models: CL-6000, CL-6500, CL-7000 (Lever start type only)

Grip Attachment for Push-to-start

PS-1 PS-1-ESD (Anti-electrostatic)

This attachment changes start type from Lever to Push.



Applicable model: CL-4000



When attached

Power Supply / Controller

Exclusive quiet power supply for DC screwdrivers to drive them safely.

- Connected to an AC outlet. It converts power to low output for DC screwdrivers.
- Please use HIOS screwdrivers in combination with a HIOS power supply for safe screw fastening.

Power Supplies for Brushless Screwdrivers

T-45BL (for one screwdriver)

Applicable to:
BLG Series
BL Series (including OPC)



T-70BL (for one screwdriver)

Applicable to:
BLG Series
BL Series
PGSeries (including OPC)



T-80BL

Coming soon

Applicable to:
BLG-BC2 Series



SPECIFICATIONS

Model	T-45BL	T-70BL	T-80BL
Primary input power supply	AC100-240V (47-63Hz)	AC100-240V (47-63Hz)	AC100-240V (47-63Hz)
Secondary output voltage	HI (2): DC30V, LOW (1): DC20V (2-step switch)	HI (2): DC30V, LOW (1): DC20V (2-step switch)	HI (2): DC30V, LOW (1): DC20V (2-step switch)
Outer dimensions (mm)	71.5 (W)×146 (D)×42.6 (H)	88 (W)×210 (D)×52 (H)	116 (W)×210 (D)×55 (H)
Weight (g)	320	685	1,370
Accessories	Power supply cord 1.8m (1 pc), flat 2P conversion plug (1 pc) (only for 100V), mounting hardware, mounting screws	Power supply cord 1.8m (1 pc), flat 2P conversion plug (1 pc) (only for 100V), mounting hardware, mounting screws	Power supply cord 1.8m (1 pc), flat 2P conversion plug (1 pc) (only for 100V), mounting hardware, mounting screws
Plug type	A / A-2 / A-3 / C / BF / S	A / A-2 / A-3 / C / BF / S	A / A-2 / A-3 / C / BF / S
Applicable screwdrivers	BLG	BLG-4000 Series / BLG-5000 Series (except for BLG-5000-18)	BLG-4000 Series / BLG-5000 Series / BLG-7000
	BL	BL-2000 Series/BL-3000 Series/BL-5000 Series	BL-2000 Series/BL-3000 Series/BL-5000 Series/BL-7000
	PG	—	PG-3000 / PG-5000 / PG-7000

Note: Use the HI speed and/or HI torque power supplies with HI setting only.

Power Supplies For Brushed Screwdrivers

CLT-45 (for one screwdriver)

Applicable to:
CL Series



CLT-60 (for one screwdriver)

Applicable to:
CL Series



CLT-80 (for one screwdriver)

Applicable to:
CL Series



SPECIFICATIONS

Model	CLT-45	CLT-60	CLT-80
Primary input power supply	AC100-240V (47-63Hz)	AC100-240V (47-63Hz)	AC100-240V (47-63Hz)
Secondary output voltage	HI (2): DC30V, LOW (1): DC20V (2-step switch)	HI (2): DC30V, LOW (1): DC20V (2-step switch)	HI (2): DC30V, LOW (1): DC20V (2-step switch)
Outer dimensions (mm)	71.5 (W)×146 (D)×42.6 (H)	88 (W)×210 (D)×52 (H)	116 (W)×210 (D)×60 (H)
Weight (g)	330	715	1,400
Accessories	Power supply cord 1.8m (1 pc), flat 2P conversion plug (1 pc) (only for 100V), mounting hardware, mounting screws	Power supply cord 1.8m (1 pc), flat 2P conversion plug (1 pc) (only for 100V), mounting hardware, mounting screws	Power supply cord 1.8m (1 pc), flat 2P conversion plug (1 pc) (only for 100V), mounting hardware, mounting screws
Plug type	A / A-2 / A-3 / C / BF / S	A / A-2 / A-3 / C / BF / S	A / A-2 / A-3 / C / BF / S
Applicable screwdrivers	CL-2000, CL-3000, CL-4000, CL-6000, CL-6500	CL-2000, CL-3000, CL-4000, CL-6000, CL-6500, CL-7000	CL-2000, CL-3000, CL-4000, CL-6000, CL-6500, CL-7000, CL-9000

Exclusive controllers for brushless screwdrivers for automated machines

Controllers featuring screwdriver rotation speed and direction switching functions as standard. The rotation speed can be chosen from 22 levels. The controllers can be used for various screw fastening operations. They can be controlled from an external device such as PLC.

BLT-AY-61 (for one screwdriver)

Applicable to:
PGF Series
BLF Series



BLT-AY-71 (for one screwdriver)

Applicable to:
PGF Series
BLF Series



SPECIFICATIONS

Model	BLT-AY-61	BLT-AY-71
Primary input power supply	AC100-240V, 47-63Hz	
Secondary output voltage	HI: DC20-30V, LOW: DC5-15V (switchable in 11 steps for both HI and LOW)	
Outer dimensions (mm)	202 (W)×143 (D)×87 (H)	
Weight (kg)	1.75	
Accessories	Power supply cord 1.8m with ground wire 1 pc, connector terminal block 1 pc	
Plug Type	A-1 / A-2 / A-3 / C / BF / S	
Applicable screwdrivers	PGF	PGF-3000, PGF-5000
	BLF	BLF-2000, BLF-5000
		PGF-7000 BLF-7000 Series

Exclusive controllers for brushed screwdrivers for automated machines

CLT-AY-61 (for one screwdriver)

Applicable to:
CLF Series, αF Series



CLT-AY-81 (for one screwdriver)

Applicable to:
CL-A Series



SPECIFICATIONS

Model	CLT-AY-61	CLT-AY-81
Primary input power supply	AC100V, 120V, 220-240V ±5% 50/60Hz	AC100V±5% 50/60Hz
Secondary output voltage	About DC17-30V (stepless)	About DC17-30V (stepless)
Outer dimensions (mm)	232 (W)×177 (D)×106 (H)	320 (W)×220 (D)×154 (H)
Weight (kg)	4.2	13.5
Accessories	Power supply cord 1.8m with ground wire 1 pc, spare fuse 1 pc, fork terminals 5 pcs	Power supply cord 1.8m with ground wire 1 pc, spare fuse 1 pc, fork terminals 5 pcs
Plug type	A-1 / A-2 / A-3 / C / BF / S	A-1
Applicable screwdrivers	CLF Series, αF Series	CL-A Series

Optional Specifications

2WV

Models: CLT-AY-61-2WV
CLT-AY-81-2WV

Low torque rotation (5-15V) can be controlled externally.

REV

Models: CLT-AY-61-REV
CLT-AY-81-REV

Reverse rotation can be controlled externally.

2WV+REV

Models: CLT-AY-61-REV-2WV
CLT-AY-81-REV-2WV

Note: These functions cannot be added after purchase.

Plug Types

Voltage	100V		120V		220-240V		
	Type A	Type A-1	Type A-2	Type A-3	Type C	Type BF	Type S
Plug Shape							

VB Series (AC Type)

100V

VB-1510

Hi Speed

VB-1510-18

Hi Torque

VB-2008



VB-1820

VB-3012

VB-4504



VB-4504 has a Shockless Stand

Hi Speed / Hi Torque

VB-3020



Lever

Push



Lever

Push

SPECIFICATIONS

Lever start model		VB-1510	VB-1510-18	VB-1820	VB-2008	VB-3012	VB-3020	VB-4504	VBH-1820	VBH-3012
Push-to-start model		VB-1510PS	VB-1510PS-18	VB-1820PS	VB-2008PS	VB-3012PS	VB-3020PS	VB-4504PS	VBH-1820PS	VBH-3012PS
AC input power (±5%)		100V			100V			100V		100V
Power consumption (W)*1		20W			40W	20W	40W	40W		40W
Output torque range (N·m)		0.25 - 1.5	0.2 - 1	0.4 - 1.8	0.4 - 2	0.5 - 3	1 - 3	1 - 4.5	3 - 7	4 - 10
Unloaded rotation speed (r.p.m)±10%		970	1,800	2,000	800	1,200	2,000	400	470	270
Screw size (mm)	Machine screw	2.0 - 4.0		2.6 - 4.0	2.0 - 4.0	3.0 - 5.0	3.0 - 5.0		5.0 - 6.0	
	Tapping screw	2.0 - 3.0		2.6 - 3.0	2.0 - 3.0	3.0 - 4.0	3.0 - 4.0		5.0 - 6.0	
Outer dimensions	Grip diameter (Max)	∅33	∅33	∅39 / ∅41 (PS)	∅33	∅39 / ∅41 (PS)	∅39 / ∅41 (PS)	∅39 / ∅45 (PS)	∅39 / ∅45 (PS)	∅39 / ∅45 (PS)
	Length (mm)	255		263 / 286 (PS)	255	263 / 286 (PS)	263 / 286 (PS)	263 / 286 (PS)	343 / 361 (PS)	
Weight (g)		526		750	526	750	750	750 / *2	2,550 (total)	
AC cord length		3m		3m			3m		3m	
Bit drive selection	Standard	H4		H5 and 5HEX (compatible)			H5 and 5HEX (compatible)	1/4HEX	1/4HEX	
	Special Order	H5 and 5HEX (compatible) or 1/4HEX		1/4HEX			1/4HEX	—	—	
Accessories	Bit (one each)	HIOS Shank	H4	+#1 (∅4×40) +#2 (∅4×40)		—		—		—
			H5	+#1 (∅5×60) +#2 (∅5×60)		+#1 (∅5×60) +#2 (∅5×60)	+#1 (∅5×60) +#2 (∅5×60)	—		
	HEX Shank	1/4HEX	+#1 (∅5.0×50), #2 (∅5.0×50) - (∅5.0×50)					—		
Torque adjustment spring		Silver	—		—			—		—
Plus screw for adjustment		—		M2.6 (pan head machine screw)			M2.6 (pan head machine screw)	—	M4×6 (hexagon socket head set screw)	
Flat 2P conversion plug		1 pc (with ground wire)		1 pc (with ground wire)			1 pc (with ground wire)		1 pc (with ground wire)	
Shockless Stand		—		—			—	●	●	●
Variations	VZQ	HIOS Shank	—	—	●	—	●	—	—	—
		HEX Shank	—	—	—	—	—	—	—	—
VB / VBH-OPC		●	●	●	●	●	●	●	●	●

*1 Power consumption is an approximate value. *2 VB-4504PS(with Shockless Stand)2,080g (total)

Ultra HI Torque

VBH-1820 (with Shockless Stand)

Ultra HI Torque

VBH-3012 (with Shockless Stand)



Lever



Push

Supports screw fastening of large equipment. HI speed & HI torque, and energy saving

- Can be directly connected to an AC outlet.
- Reduced power consumption by about 50% saves power cost.
- Hammer head stabilizes ultra-high torque screw fastening (VBH).

Plug Type

Type A / 100V

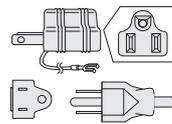

Connection with PLC

Cut the tip of the OPC dedicated cord and connect its internal lead wire to PLC.

*Applicable models: VB / VZSeries (OPC)

Depending on the model type, the time chart slightly varies. For details, please visit the HIOS website and refer to either "VB-OPC" or "VZ-OPC".

Output Torque Guide (HI Input) ❖

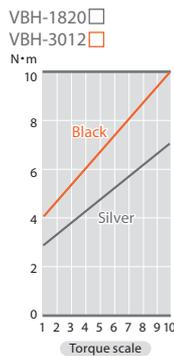
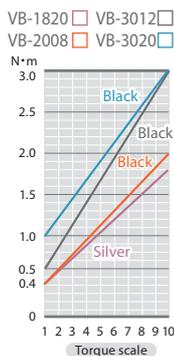
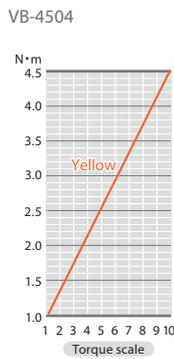
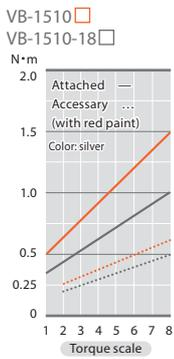

* The colors in the chart indicate the spring colors.

❖* For some models, two torque adjustment springs, for HI torque (installed) and for LOW torque (accessory), are included. Please use a suitable one for your operations.

APPLICABLE DRIVERS Variations

Suction Attachment

VZQ



See [P.51](#) ↗

Screwdrivers with Screw Counter Supported:

VB-OPC



See [P.41](#) ↗

VBH-OPC



See [P.41](#) ↗

ACCESSORIES

Pistol Attachment

PAB-18 (For Lever Start)

PAB-18PS (for Push-to-Start)

Can be converted to a pistol type.
Ideal for horizontal fastening.



Applicable model:
PAB-18...VB-1820, VB-3012, VB-3020
PAB-18PS...VB-1820PS, VB-3012PS, VB-3020PS

Angle Attachment

ANGLV-Z-CH1 (For H5 & 5HEX)*

ANGLV-Z-XX1 (1/4HEX)

By attaching this to the tip, you can work smoothly in a narrow space.



Set the output to 1.8 N·m or smaller

Applicable model:
VB-1820, VB-3012, VB-3020 (Lever Start type only)
*Angle attachment Use H5 bit when this attachment is attached. If you want to use 5HEX with the above models, please contact the HIOS distributor.

VB Series (AC Type)

120V / 220-240V

VB-1510

Hi Speed

VB-1510-18



VB-1820

VB-3012

VB-4504



VB-4504 has a shockless stand.



AC Screwdrivers

Brushless Screwdrivers VB Series

SPECIFICATIONS

Lever start model		VB-1510	VB-1510-18	VB-1820	VB-3012	VB-4504	VBH-1820	VBH-3012						
Push-to-start model		VB-1510PS	VB-1510PS-18	VB-1820PS	VB-3012PS	VB-4504PS	VBH-1820PS	VBH-3012PS						
AC input power (±5%)*1		120V 220-240V	120V 220-240V	120V 220-240V	120V 220-240V	120V 220-240V	120V 220-240V	120V 220-240V						
Power consumption (W)		20W 25W	20W 25W	40W	40W 32W	40W 32W	40W 32W	40W 32W						
Output torque range (N·m)		0.25 - 1.5	0.2 - 1	0.4 - 1.8	0.5 - 3	1 - 4.5	3 - 7	4 - 10						
Unloaded rotation speed (r.p.m)±10% [HI / LOW]		970	1,800	2,000	1,200	400	470	270						
Screw size (mm)	Machine screw	2.0 - 4.0		2.6 - 4.0	3.0 - 5.0		5.0 - 6.0							
	Tapping screw	2.0 - 3.0		2.6 - 3.0	3.0 - 4.0		5.0 - 6.0							
Outer dimensions	Grip diameter (Max)	∅33	∅33	∅39 / ∅41 (PS)	∅39 / ∅41 (PS)	∅39 / ∅45 (PS)	∅39 / ∅45 (PS)	∅39 / ∅45 (PS)						
	Length (mm)	255	255	263 / 286 (PS)		263 / 286 (PS)	343 / 361 (PS)							
Weight (g)		526	526	750	750 / *2		2,550 (total)							
ACCord length		3m		3m			3m							
Bit drive selection	Standard	H4		H5 and 5HEX (compatible)		1/4HEX	1/4HEX							
	Special Order	H5 and 5HEX (compatible) or 1/4HEX		1/4HEX		—	—							
Accessories	Bit (one each)	HIOS Shank	H4	+#1 (∅4×40) +#2 (∅4×40)		—		—						
		H5	+#1 (∅5×60) +#2 (∅5×60)		+#1 (∅5×60) +#2 (∅5×60)		—							
	HEX Shank	1/4HEX	+#1 (∅5.0×50) +#2 (∅5.0×50) - (∅5.0×50)		—		—							
	Torque adjustment spring	Silver	—	—		—		—						
Plus screw for adjustment		—		M2.6 (pan head machine screw)		—		M4 x 6 (Hexagon socket head set screw)						
Shockless Stand		—		—		●	●							
Variations	VZQ	HIOS Shank	—	—	—	—	●	●	●	●	—	—	—	—
		HEX Shank	—	—	—	—	—	—	—	—	—	—	—	—
	VB/VBH-OPC	●	▲	●	▲	●	▲	●	▲	●	▲	●	▲	●

*1 Power consumption is an approximate value. *2 VB-4504PS (with Shockless Stand): 2,080g (total weight)

120V / 220-240V

VB

Ultra HI Torque

VBH-1820 (with Shockless Stand)

Ultra HI Torque

VBH-3012 (with Shockless Stand)



Lever

Push

**Supports screw fastening of large equipment.
Energy saving AC type brushless
screwdriver.**

- Can be directly connected to an AC outlet.
- Reduced power consumption by about 50% saves power cost.
- Hammer head stabilizes ultra-high torque screw fastening (VBH)

Plug Types

Type A-2 / 120V

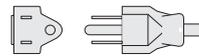

Type C / 220V-240V

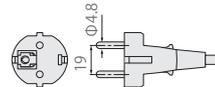

Connection with PLC

Cut the tip of the OPC dedicated cord and connect its internal lead wire to PLC.

*Applicable models: VB and VZ Series (OPC)

Depending on the model type, the time chart slightly varies. For details, please visit the HIOS website and refer to either "VB-OPC" or "VZ-OPC".

Output Torque Guide (HI Input) ❖

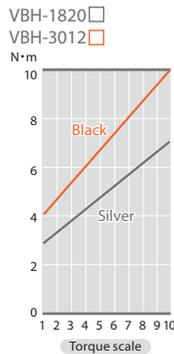
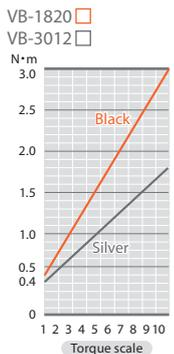
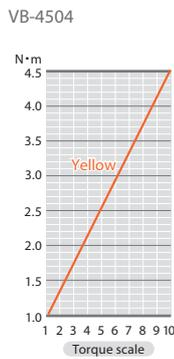
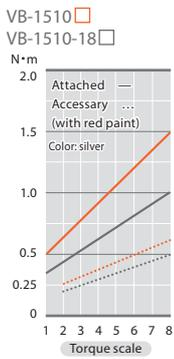

* The colors in the chart indicate the spring colors.

❖ For some models, two torque adjustment springs, for HI torque (installed) and for LOW torque (accessory), are included. Please use a suitable one for your operations.

APPLICABLE DRIVERS Variations

Suction

VZQ



Suction Part (Optional Item)

See [P.51](#)

Screwdrivers with Screw Counter Supported:

VB-OPC



See [P.41](#)

VBH-OPC



See [P.41](#)

ACCESSORIES

Pistol Attachment

PAB-18 (for Lever Start)

PAB-18PS (for Push-to-Start)

Can be converted to a pistol type.
Ideal for horizontal fastening.



Applicable models:
PAB-18... VB-1820 and VB-3012
PAB-18PS... VB-1820PS and VB-3012PS

Angle Attachment

ANGLV-Z-CH1 (for H5 & 5HEX)*

ANGLV-Z-XX1 (for 1/4HEX)

By attaching this to the tip, you can work smoothly in a narrow space.



Set the output to 1.8 N·m or smaller

Applicable models:
VB-1820, VB-3012 (Lever-to-start-type only)
* The bit should be H5 when the angle attachment is used. If you want to use 5HEX with the above models, please contact the HIOS distributor.

AC Screwdrivers

Brushless Screwdrivers VB Series

VZ Series (AC Type)

100V

VZ-1510



Lever

Push

VZ-1820

VZ-3007

VZ-3012

VZ-4506



VZ-4506 has a shockless stand.



Lever

Push

SPECIFICATIONS

Lever start model		VZ-1510	VZ-1820	VZ-3007	VZ-3012	—	VZH-1820	VZH-3012
Push-to-start model		VZ-1510PS	VZ-1820PS	VZ-3007PS	VZ-3012PS	VZ-4506PS	VZH-1820PS	VZH-3012PS
AC input power (±5%)		100V	100V			100V		
Power consumption (W)*1		26W	40W			40W		
Output torque range (N·m)		0.15 - 1.5	0.4 - 1.8	0.9 - 3		1 - 4.5	3 - 7	4 - 10
Unloaded rotation speed (r.p.m)±10%		1,000	2,000	700	1,200	600	470	270
Screw size (mm)	Machine screw	2.0 - 4.0	2.6 - 4.0	3.0 - 5.0		3.0 - 5.0	5.0 - 6.0	
	Tapping screw	2.0 - 3.0	2.6 - 3.0	3.0 - 4.0		3.0 - 4.0	5.0 - 6.0	
Outer dimensions	Grip diameter (Max)	∅33	∅37.8	∅37.8	∅37.8	∅45	∅37.8 / ∅45 (PS)	∅37.8 / ∅45 (PS)
	Length (mm)	236 / 243 (PS)	276 / 280 (PS)			280	361	
Weight (g)		497 / 502 (PS)	660			1,990 (total)	2450 (total)	
ACCord length		3m	3m			3m		
Bit drive selection	Standard	H4	H5 and 5HEX (compatible)			1/4HEX		
	Special Order	5HEX or 1/4HEX	1/4HEX			—		
Accessories	Bit (one each)	HIOS Shank	H4	—		—		
		H5	—	+#1 (∅5×60) +#2 (∅5×60)		—		
	HEX Shank	1/4HEX	+#1 (5.0×50) +#2 (5.0×50) - (5.0×50)			—		
Torque adjustment spring		Red	—			—		
Plus screw for adjustment		—	M2.6 (pan head machine screw)			M4×6 (hexagon socket head set screw)		
Carbon brush (1 pair per model)		ACL10-0490	VZ18-0480			VZ18-0480		
Flat 2P conversion plug		1 pc (with ground wire)	1 pc (with ground wire)			1 pc (with ground wire)		
Shockless Stand		—	—			●	●	
Variations	VZQ	HIOS Shank	●	●	●	●	—	—
		HEX Shank	—	—	—	—	—	—
VZ/VZH-OPC			●	●	●	●	●	●

*1 Power consumption is an approximate value.

Ultra HI Torque

VZH-1820 (with Shockless Stand)

Ultra HI Torque

VZH-3012 (with Shockless Stand)



Lever

Push

Transformerless screwdrivers suitable for heavy-duty operations

- Transformerless screwdriver with a built-in controller.
- Can be directly connected to an AC outlet for input.
- Thin and lightweight design reduces workload of long-time operation.

Plug Type

Type A / 100V

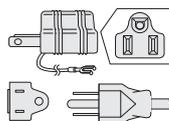

Connection with PLC

Cut the tip of the OPC dedicated cord and connect its internal lead wire to PLC.

* Applicable model: VB/VZSeries (OPC)

Depending on the model type, the time chart slightly varies. For details, please visit the HIOS website and refer to either "VB-OPC" or "VZ-OPC".

AC Screwdrivers

Brushed Screwdrivers VZ Series

Output Torque Guide (HI Input) ❖

VZ-1510

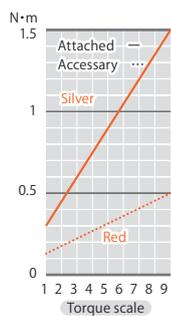

VZ-1820 □ VZ-3007 □
VZ-3012 □

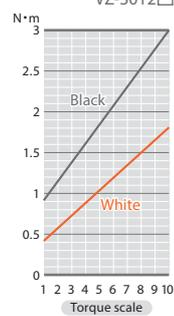

VZ-4506

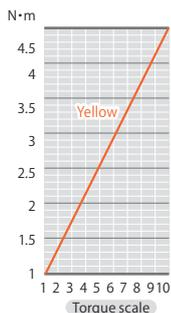

VZH-1820 □
VZH-3012 □

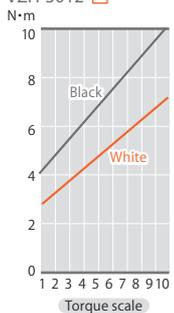

* The colors in the chart indicate the spring colors.

❖ For some models, two torque adjustment springs, for HI torque (installed) and for LOW torque (accessory), are included. Please use a suitable one for your operations.

APPLICABLE DRIVERS Variations

Suction

VZQ



See **P.51** →

Suction Part
(Optional Item)

Screwdrivers with Screw Counter Supported

VZ-OPC



See **P.41** →

VZH-OPC



See **P.41** →

ACCESSORIES

Pistol Attachment

PA-18³ (For Lever Start)

PA-18PS³ (for Push-to-Start)

Can be converted to a pistol type. Ideal for horizontal fastening.



PS Front Cover Ring

VZ18-0960³

Easy to apply load in the axial direction and the workload is reduced.



Angle Attachment

ANGLV-Z-CH1 (For H5 & 5HEX*)

ANGLV-Z-XX1 (1/4HEX)

By attaching this to the tip, you can work smoothly in a narrow space.



Applicable models:
VZ-1820 / 3007 / 3012 (Lever Start type only)

Set the output to 1.8 N·m or smaller
*4 Use H5 bit when this attachment is attached.

Protection Cover for Torque Adjustment Nut

VZ18-0970³

Prevents unexpected misalignment of the set torque position.



Shockless Stand

VZ18PS-SAS

Absorbs shock, and reduces workload. (Only for Push-to-start type)



³ Not supported for VZ-1510/VZ-4506.

VZ Series (AC Type)

120V

VZ-1820

VZ-3012

VZ-4506



Lever



Push

Ultra HI Torque

VZH-1820 (with Shockless Stand)

Ultra HI Torque

VZH-3012 (with Shockless Stand)



Lever



Push

SPECIFICATIONS

Lever start model		VZ-1812	VZ-1820	VZ-3007	VZ-3012	VZ-4504	VZ-4506	VZH-1820	VZH-3012
Push-to-start model		VZ-1812PS	VZ-1820PS	VZ-3007PS	VZ-3012PS	VZ-4504PS	VZ-4506PS	VZH-1820PS	VZH-3012PS
AC input power (±5%)		220-240V	120V	220-240V	120V	220-240V	120V	120V	120V
Power consumption (W)*1		72W	60W	72W	60W	72W	60W	60W	
Output torque range (N·m)		0.4 - 1.8		0.9 - 3		1 - 4.5		3 - 7	4 - 10
Unloaded rotation speed (r.p.m.)±10% [HI / LOW]		1,200	2,000	700	1,200	400	600	470	270
Screw size (mm)	Machine screw	2.6 - 4.0		3.0 - 5.0		3.0 - 5.0		5.0 - 6.0	
	Tapping screw	2.6 - 3.0		3.0 - 4.0		2.6 - 4.0	3.0 - 4.0	5.0 - 6.0	
Outer dimensions	Grip diameter (Max)	∅37.8	∅37.8	∅37.8	∅37.8	∅37.8	∅37.8	∅37.8 / ∅45 (PS)	∅37.8 / ∅45 (PS)
	Length (mm)	276 / 280 (PS)	276 / 280 (PS)	276 / 280 (PS)	276 / 280 (PS)	276 / 280 (PS)	276 / 280 (PS)	361	
Weight (g)		660	660	660	660	660	660 / *2	2,450 (total)	
AC cord length		3m		3m		3m		3m	
Bit drive selection	Standard	H5 and 5HEX (compatible)		H5 and 5HEX (compatible)		1/4HEX		1/4HEX	
	Special Order	1/4HEX		1/4HEX		—		—	
Accessories	Bit (one each)	HIOS Shank	H5	+#1 (∅5×60) +#2 (∅5×60)		—		—	
		HEX Shank	1/4HEX	+#1 (5.0×50) +#2 (5.0×50) - (5.0×50)		—		—	
	Plus screw for adjustment	—	M2.6 (pan head machine screw)	M2.6 (pan head machine screw)		—		M4×6 (hexagon socket head set screw)	
Carbon brush (model)		VZ18-0481B	VZ18-0480	VZ18-0481B	VZ18-0480	VZ18-0481B	VZ18-0480	VZ18-0480	
Shockless Stand		—	—	—	—	—	●	●	●
Variations	VZQ	HIOS Shank	●	●	●	●	—	—	—
		HEX Shank	—	—	—	—	—	—	—
	VZ/VZH-OPC	▲	●	▲	●	▲	●	●	●

Notes: ▲220-240V types can be used by PLC connection. Please contact the HIOS distributor for details.

*1 Power consumption is an approximate value. *2 VZ-4506PS(with Shockless Stand)1,990g (total)

Spec. P.55 →

120V / 220-240V



220-240V

VZ-1812

VZ-3007

VZ-4504



Lever



Push

Transformerless screwdrivers applicable to different voltage zone countries and suitable for heavy-duty operations

- Transformerless screwdriver with a built-in controller.
- Can be directly connected to an AC outlet.
- Thin and lightweight design reduces workload of long-time operation.

Plug Types

Type A-2 / 120V

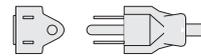

Type C / 220V-240V

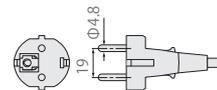

Connection with PLC

Cut the tip of the OPC dedicated cord and connect its internal lead wire to PLC.

*Applicable model: VB / VZ Series (OPC)

Depending on the model type, the time chart slightly varies. For details, please visit the HIOS website and refer to either "VB-OPC" or "VZ-OPC".

Output Torque Guide (HI Input)

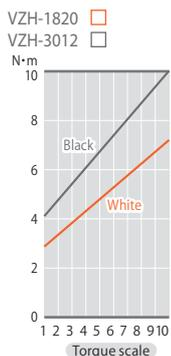
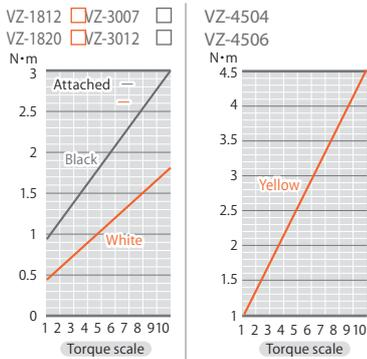

* The colors in the chart indicate the spring colors.

APPLICABLE DRIVERS Variations

Suction

VZQ



See [P.51](#) Suction Part (Optional Item)

Screwdrivers with Screw Counter Supported:

VZ-OPC



See [P.41](#)

VZH-OPC



See [P.41](#)

ACCESSORIES

Pistol Attachment

PA-18^{*3} (For Lever Start)

PA-18PS^{*3} (for Push-to-start)

Can be converted to a pistol type. Ideal for horizontal fastening.



PS Front Cover Ring

VZ18-0960^{*3}

Easy to apply load in the axial direction and the workload is reduced.



Angle Attachment

ANGLV-Z-CH1 (For H5 & 5HEX⁺)

ANGLV-Z-XX1 (1/4HEX)

By attaching this to the tip, you can work smoothly in a narrow space.



Applicable models:
VZ-1812, VZ-1820, VZ-3007,
VZ-3012 (Lever Start type only)

Set the output to 1.8 N · m or smaller

*4 Use H5 bit when this attachment is attached.

Protection Cover for Torque

Adjustment Nut
VZ18-0970^{*3}

Prevents unexpected misalignment of the set torque position.



Shockless Stand

VZ18PS-SAS (for Push-to-start)

Absorbs shock, and reduces workload. (Only for Push-to-start type)



*³ Not supported for VZ-1510/VZ-4506.

PGF Series (DC Type)

PGF-3000



PGF-5000



PGF-7000



Screwdrivers for Automated Machines(DC Type)

Brushless Screwdrivers for Automated Machines PGF Series

SPECIFICATIONS

Lever start model		PGF-3000	PGF-5000	PGF-7000
Output torque range (N·m)		0.2 - 0.55	0.4 - 1.2	1.0 - 2.8
Unloaded Rotation Speed (r.p.m) ±10%	HI (11 steps)	625 - 950	690 - 985	645 - 935
	LOW (11 steps)	115 - 325	115 - 320	210 - 595
Screw Size (mm)	Machine Screw	1.7 - 2.3	2.3 - 3.0	2.6 - 5.0
	Tapping Screw	2.0 - 2.3		2.6 - 4.0
Outer dimension to the flange (mm)		148, Ø40	179, Ø40	179, Ø40
Weight (g)		363	494	809
Applicable Controller	BLT-AY-61	●	●	—
	BLT-AY-71	—	—	●
Bit Drive Selection	Standard	H4		H5 and 5HEX (compatible)
	Special Order	—		1/4HEX
Accessories		Screwdriver cord (3m), PG-01 (optional), AC adaptor (1.5m), Sensor cord (3m), I / O flat cable (30cm), PGF-SUBBOX (optional), cord dedicated to PGF-SUBBOX (40cm), Start Torque-up Cable (40cm), converter (USB to RS-232C) (35cm), RS-232C Cable (2m), inch screws for replacement 4 pieces, software CD-ROM		
Variations	PGFQ	HIOS Shank	●	●
		HEX Shank	—	—
	PGFR	HIOS Shank	—	●
		HEX Shank	—	●

Controller [P.21](#) ↘

RELATED PRODUCTS

Control Unit (for Judgment)

PG-01 (Optional)

Reads signals from the screwdriver to decide OK / NG in real time.

- Standard: RS-232C
- Input voltage: AC100-240V (50/60Hz)
- External dimensions: 149(W)×120(D)×49(H)
- Weight: 520g



Relay Box

PGF-SUBBOX (Optional)

A relay interface that connects devices.



Controller

BLT-AY-61 / BLT-AY-71 (Optional)

Features screwdriver rotation speed and direction switching as standard.



See [P.22](#) ↘

Workflow of Pass Guard System Use

Setting the reference values for OK / NG criteria

•Memorizing acceptance criteria (teaching)
The acceptance criteria are determined by conducting an actual fastening procedure. The minimum and the maximum values of fastening torque and work time are then saved.

•Set the acceptable range (error rate setting)

The acceptable range for the minimum and maximum values of fastening torque and work time can be selected from 0, 2, 5, 10, 15 and 20%.

Actual operation

Every screw fastening is inspected in real time.

Judgment

OK / NG results are indicated by LED light and buzzer of PG-01.

Record and save the data with a PC

The measurement data can be checked and recorded by using the bundled software.

OK / NG Criteria

NG (L. NG)	Acceptable range (L. G.)	GOOD	Acceptable range (H. G.)	NG (H. NG)
Lower than L. G. value.	Within the specified % from the Good lower limit value.	Between the Good lower and upper limit values.	Within the specified % from the Good upper limit value.	Higher than H. G. value.

← NG → ← OK → ← NG →

Judging screw fastening quality and saving the data. For error detection, you can rely on the Pass Guard System

- The built-in torque sensor automatically judges every fastening (OK / NG).
- The errors that are difficult to be found visually (such as insufficient torque, unseated or cross threaded) can be detected automatically.
- All the operation data can be saved by connecting PG-01 to an external device.

Configuration of Suction Screwdriver

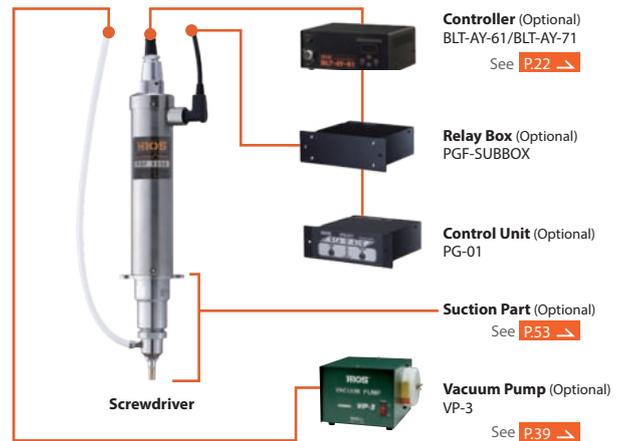

Screwdrivers for Automated Machines (DC Type)

Brushless Screwdrivers for Automated Machines PGF Series

Output Torque Guide (HI Input)

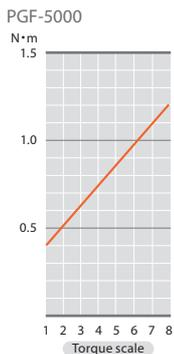
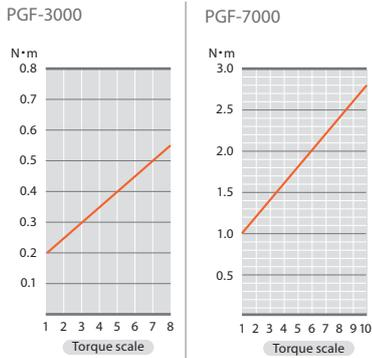

APPLICABLE DRIVERS Variations

Suction
PGFQ



For Deep Recessed Hole
PGFR (Special Order)



ACCESSORIES

Screwdriver Cord (Attached)
BLF7-0612-VI

Strong against breaking and bending.



Length: 3m (10P)
Weight: 320g

Damper Unit
BLF-DP

Absorbs impact against the workpiece while the Z-axis is descending and reduces the load on a screw and the screwdriver.



Thrust load
● Initial load: approx. 21.4 N
● Maximum load: approx. 80.4 N



When attached

BLF Series (DC Type)

BLF-2000



BLF-5000



BLF-7000

BLF-7000X

BLF-7025X



Screwdrivers for Automated Machines(DC Type)

Brushless Screwdrivers for Automated Machines BLF Series

SPECIFICATIONS

Model		BLF-2000	BLF-5000	BLF-7000	BLF-7000X	BLF-7025X	
Output torque range (N·m)		0.03 - 0.35	0.3 - 1	0.7 - 2	0.7 - 2	1.2 - 2.5	
Unloaded Rotation Speed (r.p.m) ±10%	LOW (11 steps)	120 - 345	115 - 320	150 - 450	150 - 450	120 - 350	
	HI (11 steps)	690 - 975	660 - 940	495 - 735	495 - 735	400 - 600	
Screw Size (mm)	Machine screw	1.0 - 2.3	2.0 - 3.0	3.0 - 4.0	3.0 - 4.0	3.0 - 4.0	
	Tapping screw	1.0 - 2.0	2.0 - 2.6	3.0 - 4.0	3.0 - 4.0	3.0 - 4.0	
Outer Dimension to the Flange (mm)		124, ∅38	148, ∅40	160, ∅42	160, ∅42	160, ∅42	
Weight (g)		315	470		700		
Controller	BLT-AY-61	●	●	—	—	—	
	BLT-AY-71	—	—	●	●	●	
Bit Drive Selection	Standard	H4	H5 and 5HEX (compatible)	H5	1/4HEX		
Accessories	Screwdriver Cord	3m (10P)					
	Spring	Silver					
Variations	BLFQ	HIOS Shank	●	●	●	—	—
		HEX Shank	—	—	—	—	—
	BLFR	Screw type ∅4	—	●	—	●	●

Controller [P.21](#) →

Total support for automation of screw fastening.
Please feel free to consult us solve your problems.

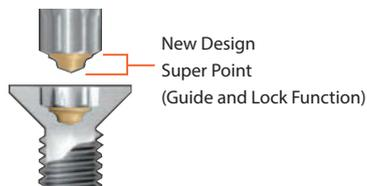

The highest ever quality for automatic screw fastening

INTRTORQUE® PAT.



With the high fitting accuracy that prevents wobbling, it is possible to fasten a screw by just turning it. It reduces damage to the workpiece and bit wear due to thrust, and always provides stable screw fastening quality.



Configuration of Suction Screwdriver

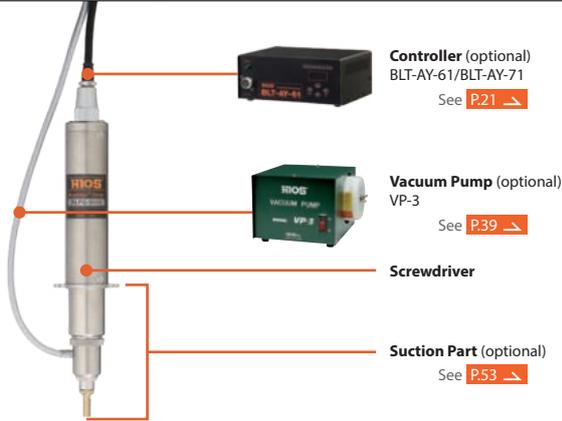

Simple structure and high durability constantly support stable torque accuracy!

- Simple control circuit and stable torque accuracy offer uniform fastening quality.
- You can externally manipulate the forward, reverse and low-speed rotations of the screwdriver (standard specification).
- Optional suction, BLFR (special order) is available - this reduces wobbling and is ideal for screw fastening in a deep recessed hole. (Special order)

RELATED PRODUCTS

Controller

BLT-AY-61 / BLT-AY-71 (Optional)

Features screwdriver rotation speed and direction switching functions as standard.

See [P.22](#)



APPLICABLE DRIVERS Variations

Suction

BLFQ



See [P.51](#)

For Deep Recessed Hole

BLFR (Special order)



See [P.53](#)

Output torque guide (HI input)*

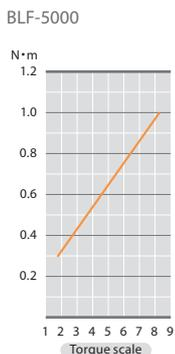
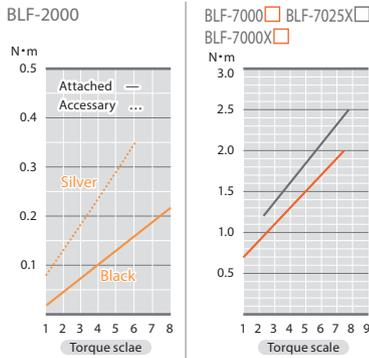

Notes:

- The torque lines in the chart show the measurements taken at the rotation speed of 30. Please refer to them as guides.
- The measurements were taken in a combination of HIOS torque meter (HP) and fidaptor (special adaptor).

*The colors in the chart indicate the spring colors.

❖ For some models, two torque adjustment springs, for HI torque (installed) and for LOW torque (accessory), are included. Please use a suitable one for your operation.

ACCESSORIES

Screwdriver Cord (Attached)

BLF7-0612-VI

Strong against breaking and bending.



Length: 3m (10P)
Weight: 320g

Damper Unit

BLF-DP

Absorbs impact against the workpiece while the Z-axis is descending and reduces the load on a screw and the screwdriver.



Thrust load
● Initial load: approx. 21.4 N
● Maximum load: approx. 80.4 N



When attached

CLF / αF / CL-A Series (DC Type)

Low Torque

CLF Series

- CLF-3000 CLF-6000
- CLF-4000 CLF-6500
- CLF-7000



HI Speed

αF Series

- αF-4500 αF-6500
- αF-5000



Screwdrivers for Automated Machines(DC Type)

Brushed Screwdrivers for Automated Machines CLF / αF / CL-A Series

SPECIFICATIONS

Model	CLF-3000	CLF-4000	CLF-6000	CLF-6500	CLF-7000	αF-4500	αF-5000	αF-6500	CL-816A	CL-825A	CL-850A
Output Torque Range (N·m)	0.03 - 0.15	0.1 - 0.35	0.3 - 0.6	0.4 - 1	0.5 - 1.5	0.4 - 0.6	0.4 - 0.75	0.5 - 1.1	1.5 - 2.5	2 - 4	2.4 - 4.5
Unloaded Rotation Speed (r.p.m)±10% [HI/LOW]	1,000 / 560		750 / 400	850 / 440	780 / 420	1,700 / 940	1,100 / 600	1,700 / 950	550 / 310	370 / 210	570 / 320
Screw Size(mm)	Machine Screw	1.0 - 2.0	1.4 - 2.6	2.0 - 3.0	2.0 - 3.0	2.0 - 4.0	2.0 - 3.0	2.0 - 3.0	3.0 - 4.0	3.0 - 4.0	4.0 - 5.0
	Tapping Screw	1.0 - 1.7	1.4 - 2.3	2.0 - 2.6	2.0 - 3.0	2.0 - 4.0	2.0 - 2.6	2.0 - 3.0	2.6 - 3.0	3.0 - 4.0	4.0 - 5.0
External Dimensions	Grip Diameter	∅32.5		∅37		∅32.5		∅37	∅50		∅62
	Total Length (mm)	182	197	234		266	207	248	251		261
Weight (g)	400	430	610	670	754	430	670	670	1,270		1,700
Bit Drive Selection	Standard	H4		H5		H4		H5	—		
	Special Order	—	1/4HEX	1/4HEX		1/4HEX		1/4HEX		1/4HEX	
Accessories	Spring	Gold	Blue	White	Yellow	—		White		Yellow	
	Cord Length	3m (5P)		3m (5P)		3m (5P)		3m (4P5P)		3m (4P4P)	
Carbon Brush Order Code (optional) 2 pcs per set	A45-0420	CL4-0420	CL65-0490		A45-0420		CL65-0490	CL9-0410		CL850-0381	
Variations	Q	HIOS Shank	●	●	●	●	●	●	●	—	—
		HEX Shank	—	—	—	—	—	—	—	—	—
	R/O/OW	HIOS Shank	●	●	●	●	●	●	●	●	●
		HEX Shank	●	●	●	●	●	●	●	●	●

* The rotation speed in the table may have some error due to fluctuations in input voltage. Please refer to the rotation speed as a guide.

* Please be careful about the flange shape because it varies depending on the wiring inside the driver or the model.

Order Code Guide for Screwdrivers for Automated Machines



Combination List

Combination Symbols	Bit Drive	Controller
HH	HIOS Shank	HIOS controller
HN	HIOS Shank	Nitto controller
XH	HEX Shank	HIOS controller
XN	HEX Shank	Nitto controller

Bit drive..... HIOS Shank (H) or HEX Shank (X)

Controller Manufactured by HIOS (H) or Nitto Seiko (N)

CLF/aF/CL-A

HI Torque

CL-A Series

CL-816A

CL-850A

CL-825A



Can be mounted to an orthogonal robot. Ideal for assembly line automation

- Stable torque accuracy helps uniform screw fastening for automation.
- With compact light weighted body, easy to install to an existing assembly system.
- Rich lineup for model selection according to the application.

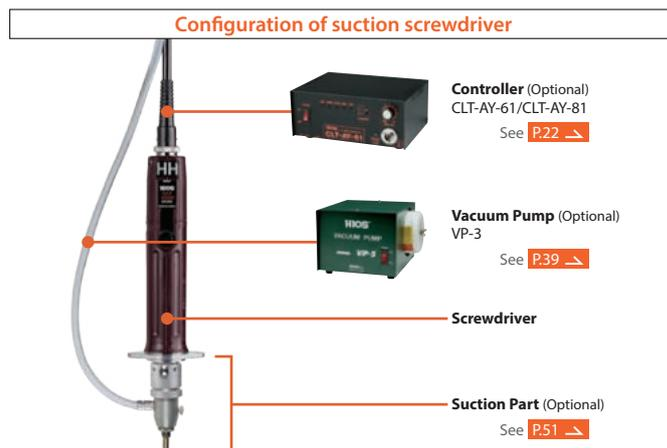

Screwdrivers for Automated Machines(DC Type)

Brushed Screwdrivers for Automated Machines CLF / aF / CL-A Series

Output Torque Guide (HI Input)*

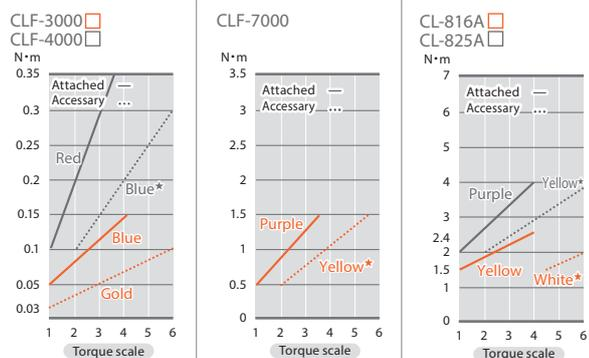

*The colors in the chart indicate the spring colors.

❖For some models, two torque adjustment springs, for HI torque (installed) and for LOW torque (accessory), are included. Please use a suitable one for your operation. Notes *1 and *2: Please note that the torque adjustment springs with ★ mark are not included in the Nitto Seiko screwdriver package.

RELATED PRODUCTS

Exclusive control unit for brushed screwdrivers for automated machines

CLT-AY-61 / CLT-AY-81

In addition to excellent durability and maintainability, this controller can adjust the rotation speed steplessly with the voltage adjustment dial. You can select I / O mode for easier control according to your system.



See [P.22](#)

About Automated Machine

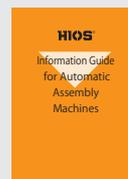

For details, please refer to the document "Screwdriver for Automated Machine Information Guide" or visit the HIOS website.
www.hios.com

APPLICABLE DRIVERS Variations

Suction Q-SET



See [P.51](#)

R Left-hand screw

The screwdriver is for left-hand screws (CCW rotation).

O Oil seal

The screwdriver has a mechanism to prevent gear grease penetration into the motor when it is installed facing upward.

OW One-way clutch

If both forward and reverse rotations are required in a line, reverse rotation achieves larger torque than forward rotation.

Other special specifications

We also supply screwdrivers with low-speed rotation (gear ratio: 25:1) or noiseless.

*When you order a product with the special specifications (R / OL / OW) other than suction screwdriver (Q-SET), please contact the HIOS distributor.

RN53 Series (DC Type / AC Type)

DC Type (Supporting RN53-200)
RD-4000



Lever

DC Type (Supporting RN53-260)
RD-4500



Lever

AC Type (Supporting RN53-300)
RD-10 / RD-15



Lever

AC Type (Supporting RN53-400)
RD-20 / RD-30



Lever

SPECIFICATIONS

Model		DC Type		AC Type				
		Recipro Model RN53-200	Recipro Model RN53-260	RN53-300		RN53-400		
Recipro Model		RD-4000	RD-4500	RD-10	RD-15	RD-20	RD-30	
Output torque Range (N·m)		0.1 - 0.55	0.3 - 0.8	0.2 - 1	0.2 - 1.5	1 - 2	1 - 3	
Unloaded Rotation Speed (r.p.m) ±10%	HI	1,000	1,700	1,500	1,000	1,600	1,000	
	LOW	690	1,200	—	—	—	—	
Screw Size (mm)	Screw Type	Machine and tapping screws		Machine and tapping screws				
	Nominal Diameter	M2.0	M2.6	M3.0		M4.0		
	Max. Length	14		14		14		
	Min. Length	Pan	6.0	7.0	8.0		8.0	
		Binding	6.0	7.0	8.0		8.0	
Flat head		8.0	9.0	9.0		12.0		
External Dimensions	Grip Diameter (∅)	32.5	32.5	33.5		39		
	Length (mm)	310	320	340		390		
Weight (g)		680	745	825		1,140		
Bit Drive (base diameter)		∅3	∅3*, ∅4*	∅4		∅4		
Controller	RDT-30	○		—		—		
	RAC-100	—		○		○		
Cord Length		2m (6P)		2m (7P)		2m (7P)		
Accessories		Mouthpiece, bit, hand screwdriver, L-shaped HEX wrench, hose and driver cord (with mist regulator), power cable, O-ring (1 pc each)						

* The bit type (∅ 3) (base diameter) of RN53-260 is for M2.6 (pan head) and bit type (∅ 4) is for M2.6 (binding head).
Note: AC-type reciprocating screwdrivers can be selected based on screw diameter.

Output Torque Guide

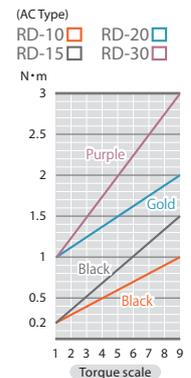
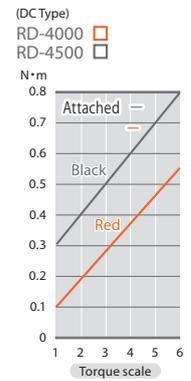

* The colors in the chart indicate the spring colors.

Recipro Screwdrivers (DC / AC Type)

Brushed Screwdrivers RN53 Series

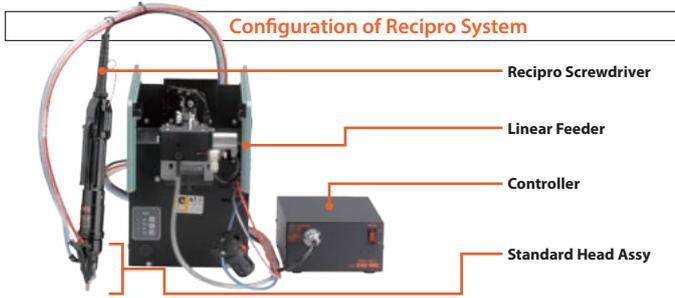

Instant screw feeding to the screwdriver bit with pressure. This helps speed-up of operations

- A linear feeder that can optimize screw feeding depending on the screw size and type.
- Supports screw fastening in a narrow place and a deep recessed hole as well.
- Parts can be easily disassembled and that contributes to great maintainability.

Combination table

Type	DC Type		AC Type	
Model	RN53-200	RN53-260	RN53-300	RN53-400
Recipro Screwdriver	RD-4000	RD-4500	RD-10 RD-15	RD-20 RD-30
Controller	RDT-30		RAC-100	
Linear feeder	FF503H		FF503H	

CONTROLLER

RDT-30 (DC20V/30V)

Applicable models
RD-4000 / RD-4500

DC Type



RAC-100 (DC100V)

Applicable models
RD-10 / RD-15
RD-20 / RD-30

AC Type



RELATED PRODUCTS

Linear Feeder
FF503H



SPECIFICATIONS

Model	RDT-30	RAC-100
Primary input power source	AC100V 50/60Hz	
Secondary output voltage	DC20/30V	DC100V
Screwdriver rotation speed setting	HI/LOW	—
External dimensions (mm)	170 (W) × 240 (D) × 100 (H)	
Weight (kg)	4.2	2.5
AC power cord (m)	1.8m with a ground wire (3L2P)	

SPECIFICATIONS

Model	FF503H	
Pneumatic control unit	Air pressure (Mpa)	0.4
	Input power source	AC100V (50/60Hz)
	Screw feeding hose length (m)	2.5m
Hopper capacity (cc)	About 450	
External dimensions (mm)	220 (W) × 412 (D) × 334.6 (H)	
Weight (kg)	About 18	

ACCESSORIES

Standard head Assy	Recipro Model	Screw Type	Detailed Dimensions (mm)						
			(a)	(b)	(c)	(d)	(e)	(f)	(g)
The dimensions (a) to (g) in the table indicate (a) to (g) in the drawing.	RN53-200	Pan head / binding	19.8	∅7.0	11.8	25	43	23.5	60
	RN53-260	Pan head	19.8	∅7.0	11.8	25	43	23.5	60
		Binding	23	∅8.0	15.5	30.5	37	18	62
	RN53-300	Pan head / binding	23	∅8.0	15.5	30.5	37	18	62
RN53-400	Pan head / binding	27	∅10	17.5	32.8	46	28.5	69	

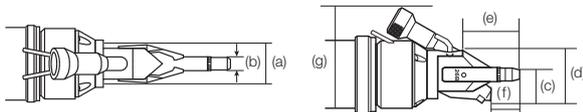

Cylinder Variations

Recipro model	Screw type	Standard (mm)	Long (mm)	Super long (mm)
RN53-200	Pan head / binding			—
RN53-260	Pan head			—
RN53-260	Binding			
RN53-300	Pan head / binding			
RN53-400	Pan head / binding		—	

Note to a customer who considers purchasing the Recipro Series: Please feel free to consult the HIOS distributor in charge of Recipro.

Peripherals and Accessories

Screwdriver Cord

BLG Series (BLG only) / BL Series / CL Series



5P (pin)



Screwdriver Cord
1.5m / 2m / 2m (anti-electrostatic) / 3m



Flex screwdriver Cord 2m
Strong against breaking and bending.



Curled Cord Max. Stretching Length 7.5m
Versatile and stretchable cord.



Extension Cord 3m / 5m
Use this when the existing cord is not long enough.

PG Series / BLG-BC2 Series / BLG-BC1 Series
BLG-ZERO1 Series / BLG-OPC Series / BL-OPC Series



6P (pin)



Screwdriver Cord 2m



Flex Cord 3m
Strong against breaking and bending.

For Suction-type Screwdrivers

Vacuum Pump

VP-3

Picks up a screw to the bit tip with vacuum pressure.



Model	VP-3
Primary Input power	AC100V, 120V, 220V-240V ±5%
Max. Power Consumption	39W±20%
Ultimate Vacuum	-350mm Hg
Air Capacity	25L / min
Dimensions (mm)	200×188×142 (H)
Weight (kg)	3.8
Plug Type	A-1/A-2/A-3/C/BF/S

Rescuing Screws

HIOS Spike® Bit D.PAT (for Precision Screws)

SPK Series

A specially designed tool to remove screws with damaged recesses. Ideal for unscrewing high-end products because its tip can bite into the recess without causing cam out.



How to Use
Hook the spike on the damaged cross, make sure the spike gets into the recess, and turn the bit while pushing the spike vertically.

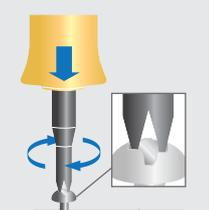

	Description		
Grip Color	Yellow	Blue	Red
Applicable Screw Size	M1.2-M1.4	M1.4-M1.7	M1.7-M2.0
3-pc Set of Spike Bits (order code)	SPK-SET01		
Single Bit (order code)	SPK-1214	SPK-1417	SPK-1720

Aluminum Handle Screwdriver

WOOD-4AL

Applicable bit
HIOS Bit H4



Unit: mm

Wooden Handle Screwdriver

WOOD-5

Applicable bit
HIOS Bit H5

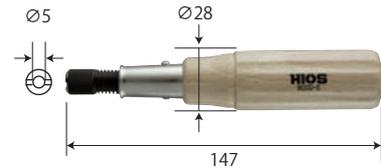

Unit: mm

Screwdriver can be securely gripped and doesn't slip!

Grip Ring TM.D.PAT

Reduces fatigue due to grip slip and improves work efficiency.

Applicable models

All models
(Except BL-2000 and CL-2000)



When attached

Dimensions of Grip Ring

Unit: mm



	Description				
Color Single color (10 pcs per pack)	Yellow GRIP-Y10	Blue GRIP-BL10	White GRIP-W10	Green GRIP-G10	Red GRIP-R10

Carbon Brush

The carbon brush should be replaced when abrasion reaches the groove on its side. Replace 2 carbon brushes at the same time.



List of carbon brushes and applicable screwdrivers (1 pair: 2 pcs)

		Applicable models	Order code
CL Series SB Series		CL-3000	A45-0420
		CL-4000, SB-400C	CL4-0420
		CL-6000, CL-6500, CL-7000 SB-650C	CL65-0490
		CL-9000	CL9-0410
VZ Series	100V	VZ-1510	ACL10-0490
	100V / 120V	VZ-1820, VZ-3007 VZ-3012, VZ-4506	VZ18-0480
	220V-240V	VZ-1812, VZ-3007 VZ-4504	VZ18-0481B

● Note: The carbon brushes for CL-2000 are enclosed type and cannot be replaced by a user. When a replacement is required, please contact the HIOS distributor.

[Guide for Replacement] Although the life of the carbon brush depends on use conditions, if you fasten about 6,000 screws a day, you have to replace the carbon brush 3 to 4 years after you started using it.

Vertical Screwdriver Operating Stand

VMS-40

For BLG Series / BL / CL / VZ-1510

VMS-50

For PG / BLG Series / BL / CL / VZ-1510

VMS-50VZ

For PG / VB / VZ (except VZ-1510)

Always keeps the screwdriver vertical to support accurate screw fastening.



SPECIFICATIONS

Model	VMS-40	VMS-50	VMS-50VZ	Model No. of Screwdriver Holder
Pole Height (mm)	515	615	615	Model No. of Screwdriver Holder
Weight (kg)	2.5	2.65	2.65	
BL Series	BL-2000 / BL-3000 / BL-5000			
CL Series	CL-2000 / CL-3000 / CL-4000 / CL-6000 / CL-6500 / CL-7000			VMS40-0180
VZ Series	—			All (except VZ-1510 Series)
				VMS-0900-VZ18
PG Series	—	PG-3000	PG-5000	VMS-0900-PG3
			PG-7000	VMS-3910-PG5
				VMS-0900-PG7
BLG-BC2	BLG-4000BC2 / BLG-5000BC2			VMS-0900-BLG45
BLG-BC1	BLG-4000BC1 / BLG-5000BC1			
BLG-ZERO1	BLG-4000ZERO1 / BLG-5000ZERO1			
BLG Series	BLG-4000 / BLG-5000			
BL Series	BL-7000			
				(Optional)
VB Series	—	VB-1510 / VB-1510PS	VB-1820 / VB-3012	VMS-0910-PG5
			VB-1820PS / VB-3012PS	VMS-0900-PG7
				VMS-0900-VB18PS
VZ Series	VZ-1510 / VZ-1510PS			VMS50-0190
Accessories	Pole 1 pc, arm stopper 1 pc, arm set 1 pc, pole holder 1 pc, base 1 pc, mount ring 1 pc (for CL-2000)*, hexagonal wrench*			

* Not included in VMS-50VZ.

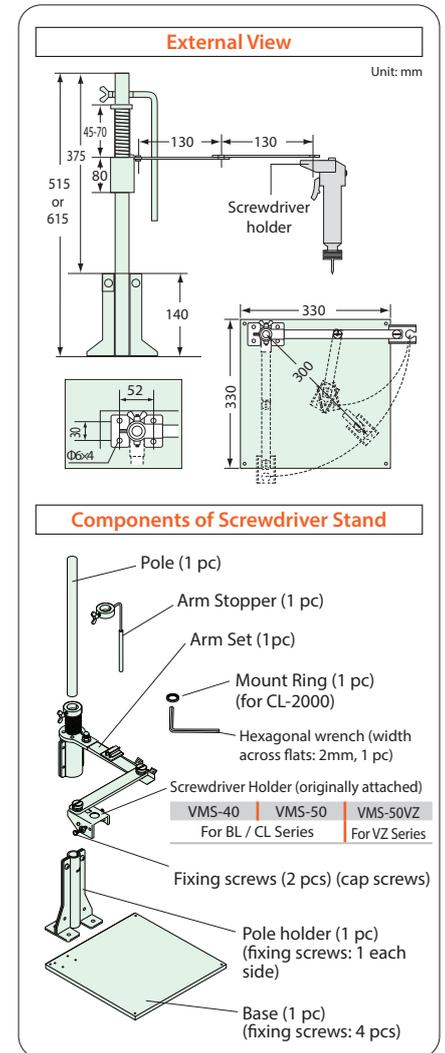

Relay Box

A relay box relays output signals from a screwdriver to an external device. Please use it to control external devices, such as screw counter.

BLOP-AF

Output signal FOR (forward), REV (reverse), T-UP (complete)

The signals (FOR, REV and T-UP) from the screwdrivers of OPC-type screwdriver with signal output function, can be extracted with this unit to connect to an external unit such as a sequencer.

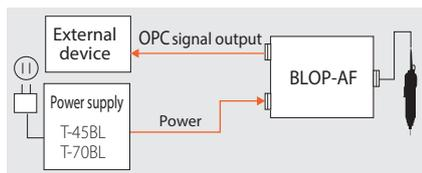

BLOP-OST2

Input signal D_ACT (start)

Output signal FOR (forward), REV (reverse), T-UP (complete)

The signals (FOR, REV and T-UP) from the OPC-type screwdriver can be output with this box to connect to an external device such as a sequencer. Also power delivery to the screwdriver can be controlled.

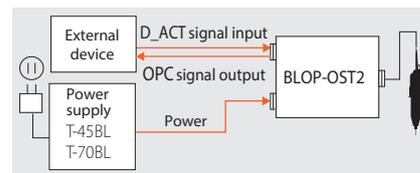

SPECIFICATIONS

Model	BLOP-AF	BLOP-OST2
Primary Input Power Source		DC30V
Secondary Output Voltage		Same as that of the primary input
External Dimensions (mm)		70(W)×42(D)×100(H)mm
Weight (g)		160
Accessories	Screwdriver cord 1.5m (1 pc), mounting hardware (2 pcs), plug for external I/O	
Applicable Models	BLG Series	BLG-4000-OPC, BLG-5000 Series-OPC
	BL Series	BL-2000-OPC, BL-3000-OPC, BL-5000 Series-OPC

STC3 / SC1 Series

Compact size counter that prevents human error of skipping

The remaining number of screws is displayed after each fastening by counting down so that skipping can be prevented. The number of screws to be fastened can be set up to 99.

- A buzzer notifies completion when the final screw has been fastened. Automatic reset enables continuous operation.
- You feel safe because it controls erroneous operations of the screwdriver and excludes unnecessary count such as reasuring fastening or retightening.
- There is a special type which you can connect with your existing HIOS power supply to use it as a counter (SC1 Series).

Screw Counter STC3 Series

BLOP-STC3 (for 1 screwdriver)

Applicable screwdrivers:

BL Series (Model: BL-OPC)
BLG Series (Model: BLG-OPC)
BLG (Model: BC2 / BC1 / ZERO1) Series*

DC Type



CLT-70STC3 (for 1 screwdriver)

Applicable screwdrivers:

CL Series (except CL-9000)

DC Type



VZOP-STC (for 1 screwdriver)

Applicable screwdrivers:

VB Series (VB-OPC / VBH-OPC)
VZ Series (VZ-OPC / VZH-OPC)
* Except AC220-240V models

AC Type



SPECIFICATIONS

Model	BLOP-STC3	CLT-70STC3	VZOP-STC	
Primary Input Power Source	AC100-240V, 47-63Hz		AC100V (50/60Hz)	AC120V (50/60Hz)
Secondary Output Voltage	HI(2): Approx. DC30V, LOW(1): Approx DC20V 2 steps		—	
External Dimensions (mm)	127(W)×208(D)×76(H)		160(W)×175(D)×84(H)	
Weight (kg)	1.8		1.5	
Connector Type	6P	5P	—	
Accessories	Power cord 1.8m (with ground wire), crimp-type terminals 8 pcs		Power cord 1.8m (with ground wire), crimp-type terminals 8 pcs	
Plug Type	A-1/A-2/A-3/C/BF/S		A-1	A-2

* These counters don't interlock with the built-in counter.

Separate Counter SC1 Series

BLOP-SC1 (for 1 screwdriver)

Applicable screwdrivers:

BL Series (BL-OPC)
BLG Series (BLG-OPC)
BLG (BC2 / BC1 / ZERO1) Series*

DC Type



CLOP-SC1 (for 1 screwdriver)

Applicable screwdrivers:

CL Series

DC Type



Example of Configuration



You need to prepare another power supply for the separate counter.

SPECIFICATIONS

Model	BLOP-SC1	CLOP-SC1
Primary Input Power Source	DC20/31V	
Secondary Output Voltage	Same as the connected power supply	
External Dimensions (mm)	110(W)×100(D)×55(H)	
Weight (g)	600	
Connector Type	6P	5P
Accessories	Power cord 1.5m 1 pc, crimp-type terminals 8 pcs	
Connectable Power Supply	T-45BL / T-70BL	CLT-45 / CLT-60 / CLT-80

* These counters don't interlock with the built-in counter.

STC3 / SC1

Model	Screw Counter			Separate Counter (external type)		
	STC3 Series		STC Series	SC1 Series		
	BLOP-STC3 (power supply type)	CLT-70STC3 (power supply type)	VZOP-STC	BLOP-SC1	CLOP-SC1	
Function						
Counting	Fastener count (1 to 99)	●	●	●	●	
	Counting Direction	Forward (count-down)	●	●	●	●
		Reverse (count-up*)	●	—	●	—
	Display	LED	●	●	●	●
		Count timer	●	●	●	●
	Built-in Timer	Workpiece set timer	●	●	●	●
		Workpiece reset timer	●	●	●	●
Reverse count timer		●	—	●	—	
External I/O	Power supply for external devices (E)	●	●	●	●	
	Control output (A, F, G)	●	●	●	●	
	Control input (B, C)	●	●	●	●	
	Error output (H)	●	●	●	●	

*1 If you unscrew during operation, the count number will go back by one.

Names and functions of components of screw counter

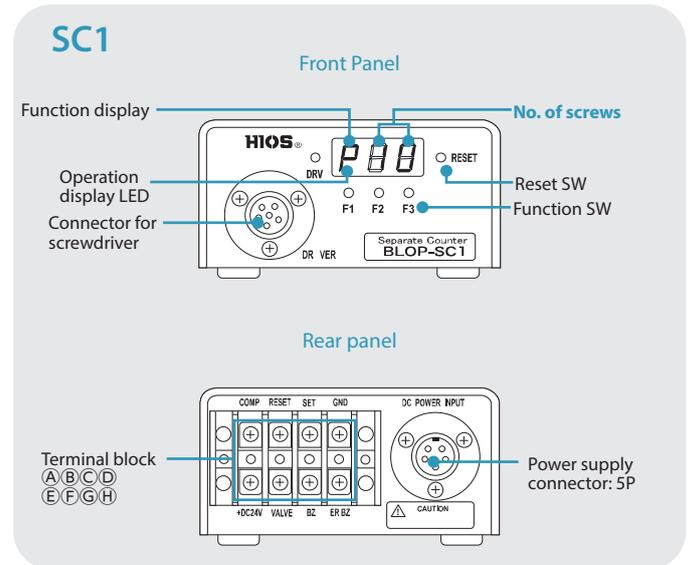
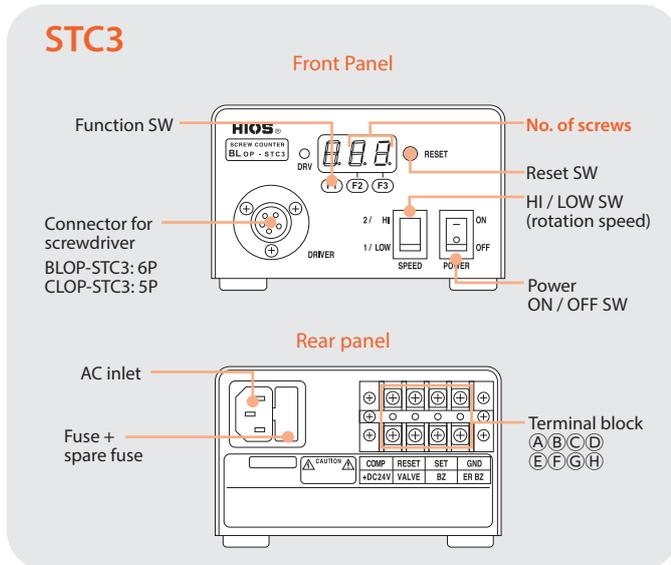

Function SW	Function	Terminal block	Signal	Description	
F1	Set fastener count (1 to 99)	A B C D E F G H	A	COMP	"Work complete" signal output terminal, open collector output
	Set count timer		B	RESET	Resets the count timer, input terminal for the "workpiece fixing release" signal from an external device
	Set workpiece set timer		C	SET	Input terminal for the "workpiece set confirmation" signal
	Set workpiece reset timer		D	GND	—
	Set reverse count timer		E	+DC24V	Power supply terminal for external device, open collector output
F2	Display the number of screws remaining. Control the sound of buzzer. Setting of ON/OFF of the reverse count control	F	VALVE	Output terminal for external device, open collector output	
		G	BZ	Work complete output terminal, open collector output	
F3	Control the normal counter operation. Setting ON/OFF of the torque-up buzzer sound control	H	ER BZ	Warning for a removed workpiece before operation complete, open collector output	

Notes:
 • Display and functions of VZOP-STC operation panel are partially different from the above.
 • CLT-70STC3 and CLOP-SC1 don't have a reverse count timer.

Plug Types

Voltage	100V		120V	220-240V			
Plug Shape	Type A	Type A-1	Type A-2	Type A-3	Type C	Type BF	Type S

HDP / HP Series

World-class measuring devices that support a wide range of torque

- Up to 100 data items can be stored in the memory and controlled. The measurement data can also be imported into your PC for management.
- With one unit of torque meter, the max, min and average torque values can be checked.
- We promptly respond to your request for calibration and maintenance services. "Inspection Report, Traceability Chart, and Calibration Certificate" is attached to all the torque meters.

HDP

Ideal for measuring the torques of loose screws and additional fastening

HDP-5



HDP-50



HDP-100 (Available on request)



SPECIFICATIONS

Model		HDP-5	HDP-50	HDP-100
Peak Measuring Range	N-m	0.015 - 0.500	0.15 - 5.00	0.15 - 10.00
	N-cm	1.5 - 50.0	15 - 500	15 - 1000
Accuracy		Within $\pm 0.5\%$ (F.S.)	Within $\pm 0.5\%$ (F.S.)	Within $\pm 0.5\%$ (F.S.)
Measuring Mode		Track, Peak, First Peak	Track, Peak, First Peak	Track, Peak, First Peak
External Dimensions (mm)	Display Unit	125×95.6×42 (H)	125×95.6×42 (H)	125×95.6×42 (H)
	Detector	104 (L)× \varnothing 21	160 (L)× \varnothing 34.5	160 (L)× \varnothing 34.5
	Detector Bit Socket	H4	H5	1/4HEX
Weight (g)	Display Unit	780	780	780
	Detector	68	250	250
Detector Cord		1.7m (P/N: DPC-0506)	1.7m (P/N: DPC-0506)	1.7m (P/N: DPC-0506)
Battery Pack (charging time)		1.2V NiMH x 5 cells 1,000mA (within 6 hours)	1.2V NiMH x 5 cells 1,000mA (within 6 hours)	1.2V NiMH x 5 cells 1,000mA (within 6 hours)
Continuous Operating Time on Full Charge		8 hours	8 hours	8 hours
Battery Life		About 300 charges	About 300 charges	About 300 charges
Exclusive Battery Charger		Input: AC 100-240V (50/60Hz) Output: DC 7.3-8V 0.5A	Input: AC 100-240V (50/60Hz) Output: DC 7.3-8V 0.5A	Input: AC 100-240V (50/60Hz) Output: DC 7.3-8V 0.5A

Standard Accessories

Model	HDP-5	HDP-50	HDP-100	HDP-5	HDP-50	HDP-100
Shank	H4	H5	1/4HEX	1/4HEX		
Bit (1 pc each)	HIOS Shank (H4) +#0×40mm +#1×40mm +#2×40mm	HIOS Shank (H5) +#0×60mm +#1×60mm +#2×60mm	HEX Shank (1/4HEX) +#1×50mm +#2×50mm	HEX Shank (1/4HEX) +#1×50mm +#2×50mm		
Auxiliary Arm	—	1 pc	1 pc	—	1 pc	
Others	● Exclusive battery charger* 1 pc Part code: TCH-MULTI ● Detector cord 1.7m 1 pc Part code: DPC-0506 ● Inspection Report 1 copy * For a battery charger to be used outside Japan, see the list on P. 67, because an applicable battery charger varies depending on the country.					

About Data Output

When you import the data into your PC, please use the input tool by Mitutoyo. Since the cord for connection is not included, please purchase it separately.

For the configuration, please inquire to the HIOS distributor.

An analog output cord is optional.

● Cord exclusively used for analog output: 1.5m (optional) P/N: HP-8060
Analog units connectable to Torque Meter: Pen Recorder, Visilite Recorder, Oscilloscope, Voltmeter, etc.

*Before use, please read the instruction manual attached to each device carefully for proper operations.

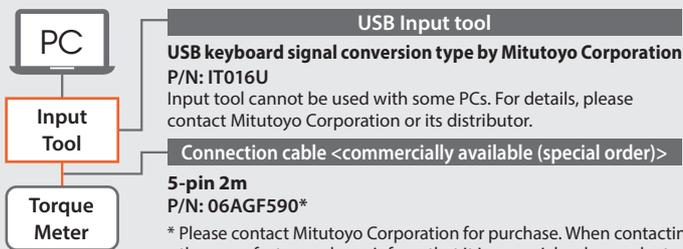

HP

This series covers a various usages including torque settings on electric screwdrivers, torque control of other tools, etc.

HP-1 (Available on request)



HP-10



HP-100



SPECIFICATIONS

Model		HP-1*	HP-10	HP-100
Peak measuring range	N-m	—	0.015 - 1.000	0.15 - 10.00
	N-cm	0.15 - 10.00	1.5 - 100.0	15 - 1000
	N-mm	1.5 - 100.0	—	—
Accuracy		Within ±0.5% (F.S.)	Within ±0.5% (F.S.)	Within ±0.5% (F.S.)
Measuring Mode		Track, Peak, First Peak	Track, Peak, First Peak	Track, Peak, First Peak
External Dimensions (mm)		230×124×65.2 (H)	230×124×65.2 (H)	230×124×65.2 (H)
Weight (kg)		1.8	1.8	1.8
Battery Pack (Charging Time)		6V NiMH 1,000mA (within 6 hours)	6V NiMH 1,000mA (within 6 hours)	6V NiMH 1,000mA (within 6 hours)
Continuous Operating Time on Full Charge		8 hours	8 hours	8 hours
Battery Life		About 300 charges	About 300 charges	About 300 charges
Exclusive Battery Charger		Input: AC 100-240V (50 / 60Hz) Output: DC 7.3-8V 0.5A	Input: AC 100-240V (50 / 60Hz) Output: DC 7.3-8V 0.5A	Input: AC 100-240V (50 / 60Hz) Output: DC 7.3-8V 0.5A

* Please ask HIOS distributor for fidaptor.

Standard Accessories

Model	HP-1	HP-10	HP-100		HP-10X	HP-100X
Fidaptor with Safety Cover	—	P/N: TF4G-Z (yellow) 1 pc	P/N: TF5G-Z (black) 1 pc		P/N: TF6SG-Z (yellow) 1 pc	P/N: TF6XG-Z (black) 1 pc
Shaft with Screw	—	—	P/N: TF5G-0010-4 1 pc  HIOS Shank H4	P/N: TF6XG-0010 1 pc  HEX Shank (2-step shaft) Upper: 5HEX Lower: 1/4HEXmm	—	—
Buffer Spring	—	—	P/N: CL65-0040 (yellow) 1 pc Measuring range: 0.15 - 0.6N•m 	—	—	P/N: CL65-0040 (yellow) 1 pc Measuring range: 0.15 - 0.6N•m 
Others	●Exclusive battery charger* 1 pc Part code: TCH-MULTI ●Grease (only for HP-100) Part code: TF-G3 1 pc ●Inspection Report 1 copy * For a battery charger to be used outside Japan, see the list on P. 67, because an applicable battery charger varies depending on the country.					

List of Applicable Fidaptors

Model	HP-10				HP-100			
	Standard Accessories	Optional Accessories			Standard Accessories	Optional Accessories		
P/N	TF4G-Z	TF6SG-Z	TF4SG-Z	TF4S-Z	TF5G-Z	TF6XG-Z	TF6U-Z* ¹	TF6UP-Z* ²
Measuring Range (N•m)	0.15 - 0.6	0.15 - 0.6	0.25 or smaller	0.25 or smaller	0.5 - 3	0.5 - 3	3 - 9	3 - 9
				Without safety cover 			Without safety cover 15mm 	Without safety cover 35mm 
Bit Drive	HIOS Shank H4	HEX Shank (2-step shaft) Upper: 5HEX, Lower: 1/4HEX	HIOS Shank H4	HIOS Shank H4	HIOS Shank H5	HEX Shank (2-step shaft) Upper: 5HEX, Lower: 1/4HEX	HEX Shank 1/4HEX	HEX Shank 1/4HEX

*1 For measuring hi-torque screwdriver (Lever Start) *2 For CL-9000

HM / HIT Series

Controls measurement by various tools with appropriate quality and precision

- Easily measures in CW (clockwise) and CCW (counterclockwise). Two units, N·m and N·cm are available.
- The measurement data can be imported into your PC for management. Data output and analog output are included in the standard specifications.
- We promptly respond to your request for calibration and maintenance services. "Inspection Report" is attached to every product.

HM

For torque control of automatic assembly machines

HM-10

HM-100



SPECIFICATIONS

Model		HM-10	HM-100
Peak Measuring Range	N-m	0.015 - 1.000	0.15 - 10.00
	N-cm	1.5 - 100.0	15 - 1000
Accuracy		Within $\pm 0.5\%$ (F.S.)	Within $\pm 0.5\%$ (F.S.)
Measuring Mode		Track, Peak	Track, Peak
External Dimensions (mm)	Torque Display	165 × 95 × 55 (H)	165 × 95 × 55 (H)
	Detector	119 × 45 × 33 (H)	119 × 45 × 33 (H)
Weight (kg)	Torque Display	1	1
	Detector	0.35	0.35
Detector Cord		1.7m (P/N: DPC-0506)	1.7m (P/N: DPC-0506)
Battery Pack (charging Time)		6V NiMH (within 8 hours)	6V NiMH (within 8 hours)
Continuous Operating Time on Full Charge		30 hours	30 hours
Battery Life		About 300 charges	About 300 charges
Exclusive Battery Charger		Input: AC100V, Output: DC 7.2V 120mA	Input: AC100V, Output: DC 7.2V 120mA

Standard Accessories

Model	HM-10	HM-100
Fidaptor with screw	P/N: TFM26-Z (Yellow) 1 pc	P/N: TFM40-Z (Black) 1 pc
Buffer Spring	—	P/N: CL65-0040 Measuring range: 0.15 - 0.6 N·m 
Screw	Replacement screws on the top of fidaptor: 5 pcs Hexagon socket head set screw for fixing: 2 pcs	
L-shaped Wrench	Width across flats 1.5mm 1 pc	Width across flats 1.5mm/2mm 1 pc
Others	<ul style="list-style-type: none"> ● Exclusive battery charger* 1 pc P/N: TCH-100N ● Detector cord 1.7m 1 pc P/N: DPC-0506 ● Inspection Report 1 copy 	

List of Applicable Fidaptors

Model	HM-10		HM-100
	Standard Accessories	Optional	Standard Accessories
Category	TFM26-Z	TFM20-Z	TFM40-Z
P/N	TFM26-Z	TFM20-Z	TFM40-Z
Measuring Range (N·m)	0.15 - 0.6	0.25 or smaller	0.5 - 3
			
Spring Color	Yellow	Red	Black
Applicable tip No.	+ #1	+ #0	+ #2
Screw Head Diameter	M2.6	M2.6	M4.0

* For a battery charger to be used outside Japan, see the list on P. 67, because an applicable battery charger varies depending on the country.

HIT

For torque control of impact screwdrivers and torque wrenches

HIT-200 (Available on request)

HIT-500 (Available on request)

HIT-2000 (Available on request)



SPECIFICATIONS

Model		HIT-200	HIT-500	HIT-2000
Peak Measuring Range	N·m	0.15 - 18.00	1.5 - 50.0	25.0 - 180.0
Accuracy		Within ± 1% (F.S.)	Within ± 1% (F.S.)	Within ± 1% (F.S.)
Measuring Mode		Track, Peak, First Peak	Track, Peak, First Peak	Track, Peak, First Peak
Dimensions of Torque Display (mm)		165×95×55 (H)	165 ×95 ×55 (H)	165 ×95 ×55 (H)
Weight (kg)	Torque Display	1	1	1
	Detector	0.85	1.65	1.65
Socket Mating Diameter		9.5 square	12.7 square	12.7 square
Detector Cord		1.7m (P/N: DPC-0506)	1.7m (P/N: DPC-0506)	1.7m (P/N: DPC-0506)
Battery Pack (Charging Time)		6V NiMH (within 8 hours)	6V NiMH (within 8 hours)	6V NiMH (within 8 hours)
Continuous Operating Time on Full Charge		30 hours	30 hours	30 hours
Battery Life		About 300 charges	About 300 charges	About 300 charges
Exclusive Battery Charger		Input: AC 100V, Output: DC 7.2V 120mA	Input: AC 100V, Output: DC 7.2V 120mA	Input: AC 100V, Output: DC 7.2V 120mA

* If your tool does not fit with the socket shape, please use a commercially available adaptor.

Related Products (Torque Meters) | HM / HIT Series

About Data Output

When you import the data into your PC, please use the input tool by Mitutoyo. Since the cord for connection is not included, please purchase it separately.

For the configuration, please inquire to the HIOS distributor.

An analog output cord is optional.

- Cord exclusively used for analog output: 1.5m (optional) P/N: HP-8060
- Analog units connectable to Torque Meter: Pen Recorder, Visilite Recorder, Oscilloscope, Voltmeter, etc.
- *Before use, please read the instruction manual attached to each device carefully for proper operations.

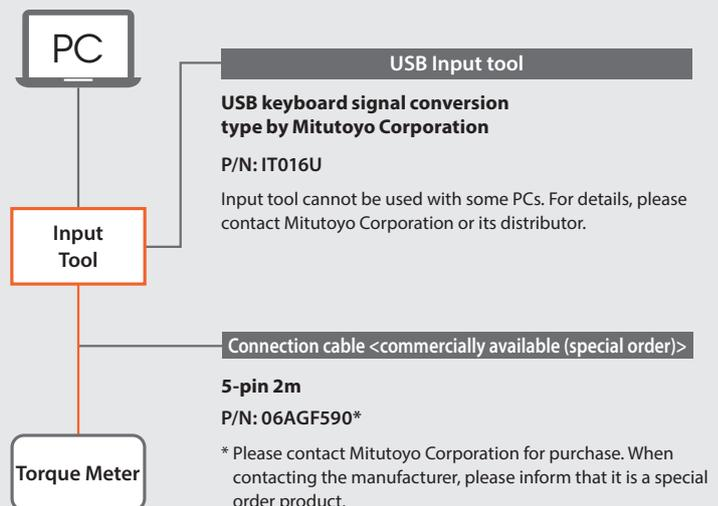

HS Series (For Manual Operation/Automated Machines)

Neji Taro aligns screws!

The work efficiency of a production line will be dramatically improved.

- A single unit can handle different screw sizes by changing rails. Easy rail replacement.
- Screws are accurately aligned and quickly fed to a line. Feeding speed can be adjusted depending on operational conditions.
- Special screws can be also handled.

- A single unit can handle eight screw sizes by simply replacing the rail.
- The Rotary Escaper has been adopted to take out screws. It has realized stable chucking of screws by eliminating tangling of screws.
- Quickly catches unstable screws. For example, countersunk screws, screws with washer and thinner head screws can be handled.
- Can be used with the vacuum pick up screwdriver (for automated machines).

- A single unit can handle three screw sizes by replacing the rail.
- A large screw capacity of approx. 150 cc.
- Can be used with the vacuum pick up screwdriver (for automated machines).

HSV Series

(for Manual Operation)



HSV-RB Series

(for Automated Machines)



HS Series

(for Manual Operation)



HS-RB Series

(for Automated Machines)



SPECIFICATIONS

Category		HSV Series (for Manual Operation)	HSV-RB Series (for Automated Machines)	HS Series (for Manual Operation)	HS-RB Series (for Automated Machines)
Take Out Screws by:		Rotary escaper		Linear rail	Slide escaper
Power Supply (AC adaptor)	Input	AC100-240V (50/60Hz)			
	Output	DC15V 1A			
Dimensions (mm)		123(W)×181(D)×145(H)		130(W)×215(D)×136(H)	134(W)×275(D)×136(H)
Weight		Approx. 3 kg (including the rail)		Approx. 3.2 kg (including the rail)	Approx. 4.2 kg (including the rail)
Screw Capacity		80cc		150cc	
Overload Protection Circuit		Reverse rotation when overloaded, Forward rotation when restored		Reverse rotation when overloaded, Forward rotation when restored	
Accessories		Hexagonal wrench (width across flats 2mm) 1 pc, screwdriver 1 pc (for timer adjustment), AC adaptor 1 pc, GND wire 1 pc, CD-ROM			

Range of Feedable Screws

Model	Nominal Screw Diameter	(D) Head Diameter (∅)	(H) Head Thickness (mm)	(L) Thread Length (mm)	Replacement Rail Model No.		
HSV (Main Unit)	HSV-10	M1.0	1.8 - 4.5	0.35 - 1.0	1.6 - 10	HSV-BI-10	
	HSV-12	M1.2	1.8 - 4.5	0.35 - 1.0	1.9 - 10	HSV-BI-12	
	HSV-14	M1.4	2.0 - 4.5	0.35 - 1.0	2.2 - 10	HSV-BI-14	
	HSV-17	M1.7	2.5 - 4.5	0.35 - 1.0	2.7 - 10	HSV-BI-17	
	HSV-20	M2.0	3.0 - 6	0.35 - 4.5	3.2 - 20	HSV-BI-20	
	HSV-23	M2.3	3.3 - 6	0.35 - 4.5	3.7 - 20	HSV-BI-23	
	HSV-26	M2.6	3.6 - 6	0.35 - 4.5	4.2 - 20	HSV-BI-26	
	HSV-30	M3.0	4.0 - 6	0.35 - 4.5	4.8 - 20	HSV-BI-30	
	HSV-RB (Main Unit)	HSV-10RB	M1.0	1.8 - 4.5	0.35 - 1.0	1.6 - 10	HSV-RI-10
		HSV-12RB	M1.2	1.8 - 4.5	0.35 - 1.0	1.9 - 10	HSV-RI-12
HSV-14RB		M1.4	2.0 - 4.5	0.35 - 1.0	2.2 - 10	HSV-RI-14	
HSV-17RB		M1.7	2.5 - 4.5	0.35 - 1.0	2.7 - 10	HSV-RI-17	
HSV-20RB		M2.0	3.0 - 6	0.35 - 4.5	3.2 - 20	HSV-RI-20	
HSV-23RB		M2.3	3.3 - 6	0.35 - 4.5	3.7 - 20	HSV-RI-23	
HSV-26RB		M2.6	3.6 - 6	0.35 - 4.5	4.2 - 20	HSV-RI-26	
HSV-30RB		M3.0	4.0 - 6	0.35 - 4.5	4.8 - 20	HSV-RI-30	

Model	Nominal Screw Diameter	(D) Head Diameter (∅)	(H) Head Thickness (mm)	(L) Thread Length (mm)	(Replacement Rail Model No.)	
HS-450 (Main Unit)	HS-35	M3.5	4.8 - 8.0	0.5 - 8.0	5.6 - 18	HS-R35
	HS-40	M4.0	5.4 - 8.0	0.5 - 8.0	6.4 - 18	HS-R40
	HS-50	M5.0	6.2 - 10.0	0.5 - 8.0	8.0 - 18	HS-R50
HS-450RB (Main Unit)	HS-35RB	M3.5	4.8 - 8.0	0.5 - 8.0	5.6 - 18	HS-R35RB
	HS-40RB	M4.0	5.4 - 8.0	0.5 - 8.0	6.4 - 18	HS-R40RB
	HS-50RB	M5.0	6.2 - 10.0	0.5 - 8.0	8.0 - 18	HS-R50RB

Screw Dimensions

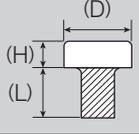
	(D)	(H)	(L)
	Head diameter (∅)	Head thickness (mm)	Thread length (mm)

- A single unit of this model can handle different screw diameters by replacing rails (8 screw sizes for the manual operation type, 6 screw sizes for the automated machines).
- High-speed feeding: 120 screws (M3 x 8) per minute on average (for automated machines)
- Can be used with the suction type (for automated machines).

- A single unit can handle different screw diameters by replacing rails (HSF-01 handles 5 screw sizes, and HSF-02 handles 3 screw sizes).
- Low-profile design with the width 55 mm is most suitable for cell production.
- It can handle screws with thin heads by adjusting the sensor.

Configuration of Screw Feeder

Main unit model	Model	Replacement rail
 Main unit only	 Main unit + applicable rail (1 pc)	 Specify the rail's model No. for ordering a rail.

HSIII Series

(for Manual Operation)



HSIII-RB Series

(for Automated Machines)



HSF Series

(for Manual Operation)



SPECIFICATIONS

Category		HSIII Series (for Manual Operation)	HSIII-RB Series (for Automated Machines)	HSF Series (for Manual Operation)
Take out screws by:		⇒ ⇒ ⇒ Linear rail	↳ Slide escaper	⇒ ⇒ ⇒ Linear rail
Power supply (AC Adaptor)	Input	AC100V-240V (50/60Hz)		AC100-240V (50 / 60Hz)
	Output	DC15V 1A		DC15V 1A
Dimensions (mm)		123(W)×181(D)×145(H)	123(W)×181(D)×144(H)	55(W)×205(D)×142.5(H)
Weight		3kg (including the rail)		Approx. 2.4kg (including the rail)
Screw Capacity		80cc		40cc
Overload Protection Circuit		Reverse rotation when overloaded, Forward rotation when restored		Reverse rotation when overloaded, Forward rotation when restored
Accessories		Hexagonal wrench (width across flats 2 mm) 1 pc, screwdriver 1 pc (for timer adjustment), AC adaptor 1 pc, gauge plate (only for manual HSIII), ground wire 1 pc, CD-ROM		Hexagonal wrench (width across flats 2 mm) 1 pc, screwdriver 1 pc (for timer adjustment), AC adaptor 1 pc, ground wire 1 pc, CD-ROM

Range of Feedable Screws

Model	Nominal Screw Diameter	(D) Head Diameter (∅)	(H) Head Thickness (mm)	(L) Thread Length (mm)	(Replacement Rail Model No.)	
HSIII-300 (Main Unit Model)	HSIII-10	M1.0	1.8 - 4.5	0.35 - 1.0	1.6 - 10	HS-SR10
	HSIII-12	M1.2	1.8 - 4.5	0.35 - 1.0	1.9 - 10	HS-SR12
	HSIII-14	M1.4	2.0 - 4.5	0.35 - 1.0	2.2 - 10	HS-SR14
	HSIII-17	M1.7	2.5 - 4.5	0.35 - 1.0	2.7 - 10	HS-SR17
	HSIII-20	M2.0	3.0 - 6	0.35 - 4.5	3.2 - 20	HS-SR20
	HSIII-23	M2.3	3.3 - 6	0.35 - 4.5	3.7 - 20	HS-SR23
	HSIII-26	M2.6	3.6 - 6	0.35 - 4.5	4.2 - 20	HS-RS26
	HSIII-30	M3.0	4.0 - 6	0.35 - 4.5	4.8 - 20	HS-SR30
HSIII-300RB (Main Unit Model)	HSIII-14RB	M1.4	2.0 - 4.5	0.35 - 1.0	2.2 - 10	HS-SR14RB
	HSIII-17RB	M1.7	2.5 - 4.5	0.35 - 1.0	2.7 - 10	HS-SR17RB
	HSIII-20RB	M2.0	3.0 - 6	0.35 - 4.5	3.2 - 20	HS-SR20RB
	HSIII-23RB	M2.3	3.3 - 6	0.35 - 4.5	3.7 - 20	HS-SR23RB
	HSIII-26RB	M2.6	3.6 - 6	0.35 - 4.5	4.2 - 20	HS-SR26RB
	HSIII-30RB	M3.0	4.0 - 6	0.35 - 4.5	4.8 - 20	HS-SR30RB

Model	Nominal Screw Diameter	(D) Head Diameter (∅)	(H) Head Thickness (mm)	(L) Thread Length (mm)	(Replacement Rail Model No.)	
HSF-01 (Main Unit Model)	HSF-10	M1.0	1.8 - 2.0	0.35 - 1.0	1.6 - 10	HS-WR10
	HSF-12	M1.2	1.8 - 2.3	0.35 - 1.0	1.9 - 10	HS-WR12
	HSF-14	M1.4	2.0 - 2.5	0.35 - 1.0	2.2 - 10	HS-WR14
	HSF-17	M1.7	2.5 - 3.0	0.35 - 1.0	2.7 - 10	HS-WR17
	HSF-20	M2.0	3.0 - 4.0	0.35 - 1.3	3.2 - 16	HS-WR20
HSF-02 (Main Unit Model)	HSF-23	M2.3	3.5 - 4.0	0.35 - 1.5	3.7 - 16	HS-WR23
	HSF-26	M2.6	4.0 - 4.5	0.35 - 1.7	4.2 - 16	HS-WR26
	HSF-30	M3.0	5.0 - 5.5	0.35 - 2.0	4.8 - 16	HS-WR30

About Dimensions of Screw Feeders

The dimensions in the chart don't include projections and depressions. See HIOS website for details.

www.hios.com

DOWNLOAD ► DXF ► Automatic screw feeder

BL-SB / SB Series (DC Type)

Brushless Screwdriver
BL-5000SB



The tap penetrates to the depth set by the stopper.

Lever

Brushless Screwdriver
BL-7000SB



Lever

Brushed Screwdrivers
SB-400C



The tap penetrates to the depth set by the stopper.

Lever

SPECIFICATIONS

Lever Start Model		BL-5000SB	BL-7000SB	SB-400C	SB-650C
Tapping Capacity (mm)		0.9 - 2.6	2.0 - 4.0	0.9 - 2.6	2.0 - 4.0
Chuck Diameter (mm)		Max. 4mm	Max. 6.5mm	Max.4mm	Max.6.5mm
Safe Load Torque Adjustable Range (N-m)		0.2 - 1.2	0.7 - 2.8	0.1 - 0.55	0.3 - 1.6
Unloaded Rotation Speed (r.p.m.) ±10% (HI/LOW)		900 / 590	1,500 / 1,000	1,000 / 670	900 / 600
External Dimensions	Grip Diameter(∅)	Max : 38 Min : 32	Max : 40 Min : 36	32	37
	Length (mm)	233	280	220	295
	Width (mm)	48.8	57.5	—	—
Weight (g)		405	765	450	750
Applicable Power Supply	T-45BL	●	—	●	●
	T-70BL	●	●	—	—
Carbon Brush Model (Optional)		—		CL4-0420 (2 pieces per pair)	CL65-0490 (2 pieces per pair)
Accessories	Stopper (one each)	∅2.0mm / ∅2.3mm / ∅2.6mm	∅2.6mm / ∅3.0mm / ∅4.0mm	∅2.0mm / ∅2.3mm / ∅2.6mm	∅2.6mm / ∅3.0mm / ∅4.0mm
	Chuck key 1 pc				
	Cord length	1.5m (5P)	2m (5P)	1.5m (5P)	2m (5P)
	L-shaped Wrench	Width Across Flat 5 mm 1 pc			

BL-SB / SB

Brushed Screwdriver
SB-650C



Lever

With an automatic reversal mechanism, this tool detects overloading and prevents tap damage.

- A tapping tool for components with pilot holes.
- Automatically detects excessive load on the tap and the pilot hole width, and prevents tap damage.
- Thread deburring to remove paint or adhesive residue in the thread can be easily done.



DC Screwdrivers (Electric Tappers)

BL/SB / SB Series

Output torque Guide (HI Input)

BL-5000SB

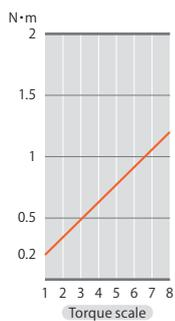

SB-400C

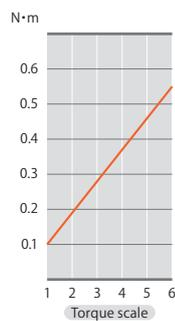

BL-7000SB

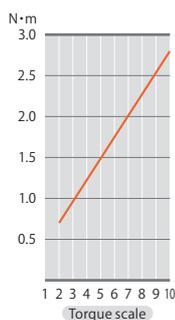

SB-650C

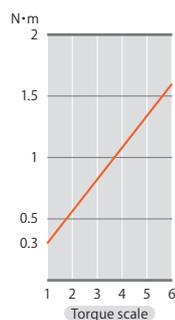

RELATED PRODUCTS

Controller
SBC-1



The rotation reverses when tapping is complete or when overloading is detected to prevent tap breakage.

Specifications

Model	SBC-1
External Dimensions (mm)	70×100×42
Weight (g)	153.5
Applicable Tapper	SB-400C, SB-650C
Applicable Power Supply	T-45BL
Accessories	Brackets x 2, Double-sided tapes x 2

POWER SUPPLY

T-45BL



Applicable models: BL-5000SB, SB-400C, SB-650C

See [P.21](#) →

T-70BL



Applicable models: BL-5000SB, BL-7000SB

See [P.21](#) →

Accessories for Suction Screwdrivers

The size varies depending on the model, please refer to the compatible accessory chart.

Configuration

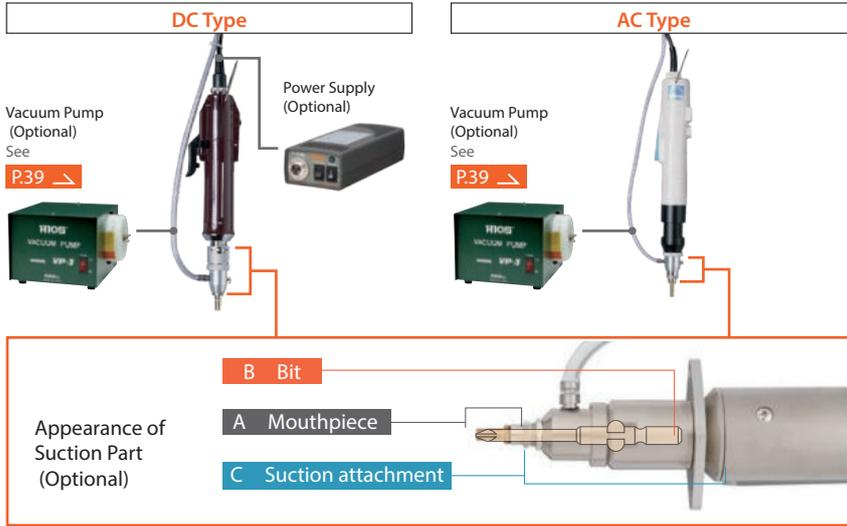

PGF Series / BLF Series / CL Series / CLF Series / aF Series / VZ Series

- Suction attachments are included in standard models. Therefore, please purchase **A** and **B** while checking the order code.
- If you want to use an existing screwdriver with the suction attachment, please purchase **A**, **B**, and **C**.

BLG Series / PG Series / BL Series / VB Series

- If you want to use a purchased screwdriver with the suction attachment, please purchase **A**, **B**, and **C**.

Compatible Accessory Chart

Category	Model	A Mouthpiece	B Applicable Bit	C Suction Attachment			
				Standard	ESD	Appearance	
				BLG-4000 Series	F3 Std.18mm	H4 60mm	BLGQ4-SET
BLG-4000BC2-LT	F3 Std.18mm	H4 60mm	CLQ2-SET	CLQ2-SET-ESD			
BLG-BC2 Series BLG-BC1 Series BLG-ZERO1 Series BLG Series	BLG-5000 Series	F3 Std.18mm	H4 40mm	BLQ5-SET	BLQ5-SET-ESD		
	BLG-5000-15 Series		H4 60mm	BLQ5N-SET	BLQ5N-SET-ESD		
	BLG-5000-18 Series BLG-5000-HT Series	Please contact the HIOS distributor.					
	BLG-7000BC2	F6 Std. 31mm	H5 80mm	BLQ7-SET	BLQ7-SET-ESD		
PG Series	PG-3000	F3Std.18mm	H4 60mm	PGQ3-SET	—		
	PG-5000	F3Std.18mm	H4 60mm	PGQ5-SET	—		
	PG-7000	F6Std.31mm	H5 80mm	PGQ7-SET	—		
BL Series	BL-2000 Series	F3 Std.18mm	H4 60mm	CLQ2-SET	CLQ2-SET-ESD		
	BL-300 Series			BLQ3N-SET	BLQ3N-SET-ESD		
	BL-5000 Series	F3 Std.18mm	H4 40mm	BLQ5-SET	BLQ5-SET-ESD		
			H4 60mm	BLQ5N-SET	BLQ5N-SET-ESD		
BL-7000	F6 Std. 31mm	H5 80mm	BLQ7-SET	BLQ7-SET-ESD			
PGF Series	PGFQ	F3 Std.18mm	H4 80mm	PGFQ3-SET	—		
				PGFQ5-SET	—		
				PGFQ7-SET	—		
	PGFR (Special Order)	PGFR-5000 / PGFR-7000	▶ See P. 54	▶ See P. 54	▶ See P. 53	▶ See P. 53	
BLF Series	BLFQ	BLFQ-2000	F3 Std.18mm	H4 60mm	BLFQ2-SET	—	
		BLFQ-5000	F6 Std. 31mm	H5 100mm	BLFQ5-SET	—	
		BLFQ-7000			BLFQ7-SET	—	
	BLFR (Special Order)	BLFR-5000 / 7000X / 7025X	▶ See P. 54	▶ See P. 54	▶ See P. 53	▶ See P. 53	
CL Series	CLQ-2000	F3 Std.18mm	H4 60mm	CLQ2-SET	CLQ2-SET-ESD		
	CLQ-3000 / 4000			CLQ4-SET	CLQ4-SET-ESD		
	CLQ-6000 / 6500 / 7000	F6 Std. 31mm	H5 80mm	CLQ65-SET	CLQ65-SET-ESD		
CLF Series aF Series	CLFQ-3000 / 4000 aFQ-4500 / 5000	F3 Std.18mm	H4 60mm	CLFQ4-SET	—		
	CLFQ-6000 / 6500 / 7000 / aFQ-6500	F6 Std. 36mm	H5 100mm	CLFQ65-SET	—		
VB Series	VB-3020	F6 Std. 31mm	H5 100mm	VZQ18-SET	—		
	VB-1820 / 3012			VZQ10-SET			
VZ Series	VZQ-1510	F3 Std. 18mm	H4 60mm	VZQ10-SET	—		
	VZQ-1812 / 1820 3007 / 3012	F6 Std. 31mm	H5 100mm	VZQ18-SET			

Related Products Accessories for Suction Screwdrivers (Suction Attachment / Mouthpiece / Bit)

A Mouthpiece

F3 Std. 18mm (Total Length)

Cross-sectional view of a mouthpiece

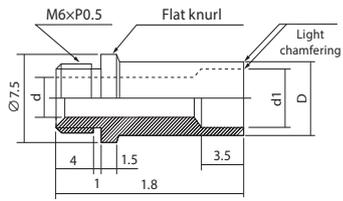

The material of the mouthpiece is BS (brass) only.

Order Code	Mouthpiece Reference Dimensions (mm)			Screw Head Shape and Screw Size		
	D	d	d1	JIS Plus (Machine Screw)	JCIS Plus	JIS Minus (Machine Screw)
F3-00	7.5	—	—	Custom screw	Custom screw	Custom screw
F3-01	3.3	2.1	2.1		Class 1 M1.4	
F3-02	3.6	2.6	2.6		Class 1 M1.7 / Class 3 M1.4	
F3-03	4.1	3.1	3.1		Class 1 M2.0 / Class 3 M1.7	
F3-04	4.6	3.6	3.6	Pan, round M2.0	Class 1 M2.3 / Class 3 M2.0	Pan, round, flat M2.0 / countersunk, round countersunk M1.7
F3-05	5.1	4.1	4.1	Pan, round M2.3 / countersunk, round countersunk M2.0	Class 1 M2.6 / Class 3 M2.3	countersunk, round countersunk M2.0
F3-06	5.8	4.3	4.5	Pan, round M2.6	Class 3 M2.6	Binding M2.0
F3-07	7.0	4.3	5.5	Pan, round M3.0 / Binding M2.6		Pan, round, flat M3.0 / Binding M2.6
F3-10	5.5	4.3	4.3	Binding M2.0		Pan, round, flat M2.3
F3-11	6.0	4.0	4.9	Binding M2.3		Binding M2.3
F3-15	3.8	2.8	2.8			Pan, round, flat M1.4
F3-16	3.5	2.5	2.5			countersunk, round countersunk, M1.2
F3-17	4.3	3.3	3.3			Pan, round, flat M1.7

● For different specifications, please contact the HIOS distributor. ● 3 mouthpieces per pack.

B Applicable bit

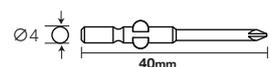
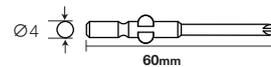
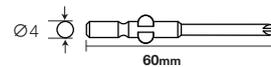
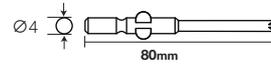
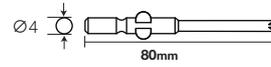
H4	Screw Recess	Screw Size	Bit	Order Code
	JIS plus	M2.0-M2.6	BP-H4-#1-3.0-40 (60)(80)	BP4130040(60)(80)
	JCIS plus	M3.0	BP-H4-#2-4.0-40 (60)(80)	BP4240040(60)(80)
	JCIS plus	M1.4 Class 1	BP-H4-#0-1.8-40 (S)(60)(80)	BP4018040 (S)(60)(80)
	JIS plus	M1.4-M1.7	BP-H4-#0-2.0-40(60)(80)	BP4020040(60)(80)
	JIS plus	M2.0-M2.6	BP-H4-#0-2.5-40(60)(80)	BP4025040(60)(80)
	JIS minus	M1.2	BS-H4-2.0-40(60)(80)	BS420040(60)(80)
	JIS minus	M1.4	BS-H4-2.5-40(60)(80)	BS425040(60)(80)
	JIS minus	M1.7-M2.0	BS-H4-3.0-40(60)(80)	BS430040(60)(80)
	JIS minus	M2.3-M3.0	BS-H4-4.0-40(60)(80)	BS440040(60)(80)

● The () in the list means total length of the bit.
● For special order item 1.8 x 40, please contact the HIOS distributor.

A Mouthpiece

F6 Std. 31mm (Total length)

Cross-sectional view of mouthpiece A

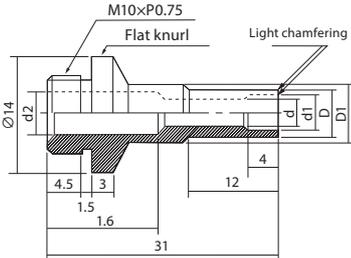

Cross-sectional view of mouthpiece B

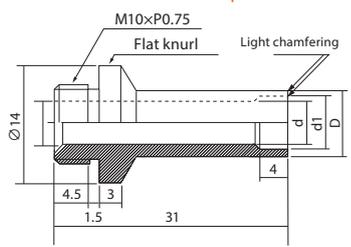

The material of a mouthpiece is BS (brass) only.

Drawing	Order Code	Mouthpiece Reference Dimensions (mm)					Screw Head Shape and Screw Size	
		D	D1	d	d1	d2	JIS Plus (Machine screw)	JIS Minus (Machine Screw)
B	F6-00	8.0	—	—	—	—	Custom screw	Custom screw
A	F6-01	4.6	7.0	3.5	3.6	5.5	Pan, round M2.0	Pan, round M2.0
	F6-02	5.1	7.0	3.5	4.1	5.5	Pan, round M2.3 / countersunk, round countersunk M2.0	Pan, round M2.3
	F6-03	5.8	7.0	3.5	4.5	5.5	Pan, round M2.6 / Binding, truss M2.0	Binding, truss M2.0
B	F6-04	7.0	—	5.5	5.5	—	Pan, round M3.0 / Binding M2.6	Pan, round M3.0 / Binding M2.6
	F6-05	7.5	—	5.5	6.0	—	Countersunk, round countersunk M3.0	Truss M2.6
	F6-06	8.5	—	5.5	7.0	—	Pan, round M4.0 / truss M3.0	Pan, round M4.0 / truss M3.0
A	F6-09	6.5	7.0	3.5	5.2	5.5	Countersunk, round countersunk M2.6	Truss M2.3
	F6-10	14.0	—	—	—	—	Custom screw	Custom screw
	F6-11	7.7	—	5.5	6.3	—	Binding M3.0	Binding M3.0
B	F6-13	9.7	—	5.5	8.3	—	Binding M4.0	
	F6-16*	9.4	—	5.5	8.0	—	Countersunk, round countersunk M4.0	
	F6-22*	9.7	—	7.5	8.3	—		Binding M4.0

* Special order ● For different specifications, please contact the HIOS distributor. ● 3 mouthpieces per pack.

B Applicable Bit

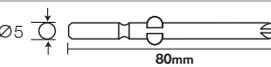
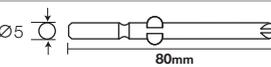
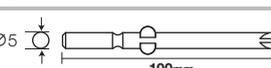
H5	Screw Recess	Screw Size	Bit	Order Code
	JIS plus	M2.0-M2.6	BP-H5-#1-3.0x80	BP5130080
	JIS plus	M3.0-M5.0	BP-H5-#2-5.0x80	BP5250080
	JIS minus	M2.0-M2.3	BS-H5-3.0x80	BS530080
	JIS minus	M3.0-M4.0	BS-H5-5.0x80	BS550080
	H5	Screw Recess	Screw Size	Bit
	JIS plus	M2.0-M2.6	BP-H5-#1-3.0-100	BP5130100
	JIS plus	M3.0-M5.0	BP-H5-#2-5.0-100	BP5250100
	JIS minus	M3.0-M4.0	BS-H5-5.0-100	BS550100

● Truss: For M3.0, use #1.

For Automatic Assembly
Special Order

Accessories for Suction Screwdrivers

Suction attachments for screwdrivers for automated machines, PGF and BLF series. Suitable for fastening screws in deep recessed holes (FR specifications)

- Suction attachment ideal for robot operation. Torque adjustment and bit replacement can be done while the attachment is attached to the screwdriver.
- A spring is built in the mouthpiece. There are a self-adjustable inner mouthpiece type, a self-adjustable outer mouthpiece type and a non-contact type that prevents workpiece damage.
- Compared with the existing HIOS Mouthpiece, the ultimate vacuum of the FR Mouthpiece is higher and that helps to reduce screw vacuum errors.
- The edge of the FR Mouthpiece touches parallel to the screw head for better uprightness of the screw.
- A long bit holder prevents cross threaded screws.

Configuration

PGF Series / BLF Series

- Suction attachments are included in standard models (PGFR / BLFR). Please purchase A and B while checking the order code.
- If you want to use an existing screwdriver with the suction attachment, please purchase A, B and C.

Controller (Optional)

See P.22



Vacuum Pump (Optional)

See P.39

Appearance of the suction part (Optional)

C Suction Attachment ASSY

A Mouthpiece with Spring

Torque adjustment nut

Internal configuration

B Screw Type

Bit holder ASSY

C Suction Attachment ASSY

SPECIFICATIONS

Model	Mode and Appearance	External Dimensions
PGFR-5000	PGFR5-SA 	 Tilt angle 45 degrees, 360 degrees rotation Dimensions: 2.4, 102, 35.1, 17.4, 70, 17, 196.2, 4, 08, 012
BLFR-5000	BLFR5-SA 	Bit Holder ASSY Specifications For PGFR-5000: Holder length 122.8 mm; bit drive H4 (P/N: PGFR5-3060) For BLFR-5000: Holder length 122.8 mm; bit drive 5HEX (P/N: BLFR5-3060)
PGFR-7000	PGFR7-SA 	 Tilt angle 45 degrees, 360 degrees rotation Dimensions: 2.4, 102, 35.1, 17.4, 70, 17, 162.8, 3.7, 08, 012
BLFR-7000X BLFR-7025X	BLFR7-SA 	Bit holder ASSY Specifications Bit holder Assy specifications Holder length 122.8 mm; bit drive 1/4HEX (P/N: BLFR7-3060)

*The hose is optional. Please order it separately. Order code: RM-0850 (Please specify the length in one-meter increments.) [Hose specifications] Inner diameter $\varnothing 4$ x outer diameter $\varnothing 6$

Related Products

Accessories for Suction Screwdrivers for Automated Machines (Suction Attachment / Mouthpiece / Bit)

B Screw-on-type Bit

Bit can be replaced easily by reversing itself.

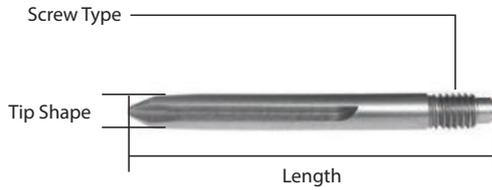

Specifications

Model	Tip Shape	Length (L)	Tip Diameter	P/N
PGFR-5000 PGFR-7000 BLFR-5000	+ #1	40mm	∅4	RBP4140S
BLFR-7000X BLFR-7025X	+ #2	40mm	∅4	RBP4240S

A Mouthpiece with Spring

Identification of mouthpiece P/N

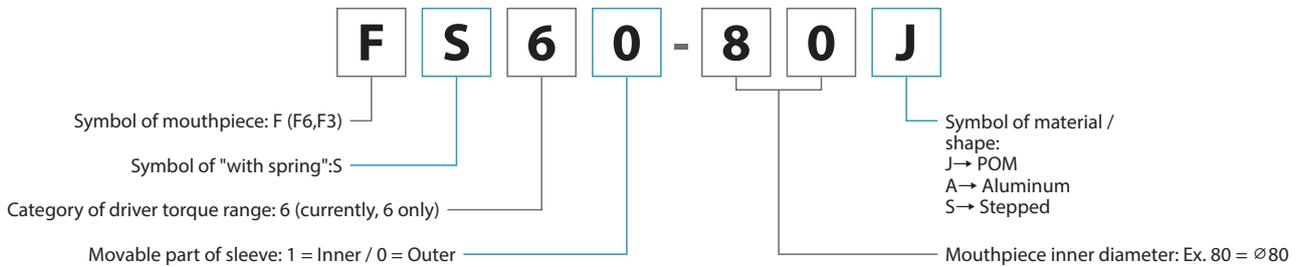

SPECIFICATIONS

P/N	Self-adjustable Inner Mouthpiece Type	Model	Self-adjustable Outer Mouthpiece Type
FS61-68	17.5 ∅6.8 When vacuuming a screw	FS60-68J / FS60-68A	17.4 ∅6.8 When vacuuming a screw POM: FS60-68J Aluminum: FS60-68A
FS61-68S	∅5.6 ∅4 When vacuuming a screw		
FS61-74	∅9 ∅7.4 When vacuuming a screw	FS60-80J	∅10 ∅8 When vacuuming a screw

Applicable screw guide chart for Mouthpiece with Spring

Screw Size	M2.6			M3.0			M4.0					
	Pan	Binding	Truss	Pan	Binding	Truss	Pan	Binding	Truss			
Model	FS61-68 FS61-68S			FS61-68 FS61-68S			FS60-68J FS60-68A FS61-68S FS61-74			FS60-68J FS60-68A FS61-68S FS61-74		
PGFR-5000 BLFR-5000												
PGFR-7000 BLFR-7000X BLFR-7025X	FS60-80J			FS60-80J			FS60-80J					

International Standard Certifications

1	2	3	4
CE	CQC	CCC	UL cUL
European Safety Standard CE Compliant Products	China Quality Certification CQC Compliant Products	China Compulsory Certification CCC Compliant Products	US Canada Safety Standards UL / cUL Compliant Products

Model	1	2	3	4	5	6	7	8
CL Series (Lever ST)								
CL-2000	○	○	—	—	—	○	○	○
CL-3000	—	○	—	—	—	○	○	○
CL-4000	—	○	—	—	—	○	○	○
CL-6000	—	—	—	—	—	○	○	○
CL-6500	—	○	—	—	—	○	○	○
CL-7000	—	○	—	—	—	○	○	○
CL-9000	—	○	—	—	—	○	○	○

Model	1	2	3	4	5	6	7	8
CL Series (Push ST)								
CL-4000PS	—	—	—	—	—	○	○	○
CL-6000PS	—	—	—	—	—	○	○	○
CL-6500PS	—	○	—	—	—	○	○	○
CL-7000PS	—	○	—	—	—	○	○	○

Model	1	2	3	4	5	6	7	8
Q-ESD suction & anti-electrostatic								
CLQ-ESD Series	—	—	—	—	—	○	○	○

Model	1	2	3	4	5	6	7	8
Q-CR suction & clean room								
CLQ-CR Series	—	—	—	—	—	○	○	○

Model	1	2	3	4	5	6	7	8
Q-CR-ESD clean room & anti-electrostatic								
CLQ-CR-ESD Series	—	—	—	—	—	○	○	○

Model	1	2	3	4	5	6	7	8
NL noiseless								
CL-3000NL	—	—	—	—	—	○	○	○
CL-4000NL	○	—	—	—	—	○	○	○
CL-6000NL	○	—	—	—	—	○	○	○
CL-6500NL	○	—	—	—	—	○	○	○
CL-7000NL	○	—	—	—	—	○	○	○
CL-9000NL	○	—	—	—	—	○	○	○

Model	1	2	3	4	5	6	7	8
BLG-BC2 Series								
BLG-4000BC2	○	○	—	—	○	—	○	○
BLG-4000BC2-LT	○	○	—	—	○	—	○	○
BLG-5000BC2	○	○	—	—	○	—	○	○
BLG-5000BC2-15	○	○	—	—	○	—	○	○
BLG-5000BC2-18	○	○	—	—	○	—	○	○
BLG-5000BC2-HT	○	○	—	—	○	—	○	○
BLG-7000BC2	○	○	—	—	○	—	○	○
Box BLG-IO-Pro1	—	—	—	—	—	○	○	○

Model	1	2	3	4	5	6	7	8
BLG-BC1 Series								
BLG-4000BC1	○	○	—	—	○	—	○	○
BLG-5000BC1 Series	○	○	—	—	○	—	○	○

Model	1	2	3	4	5	6	7	8
BLG-ZERO1 Series								
BLG-4000 Series ZERO1	○	○	—	—	○	—	○	○
BLG-5000 Series ZERO1	○	○	—	—	○	—	○	○

Model	1	2	3	4	5	6	7	8
OPC screwdrivers supporting OPC Screw Counter								
BLG-4000 Series -OPC	○	○	—	—	○	—	○	○
BLG-5000 Series -OPC	○	○	—	—	○	—	○	○

Model	1	2	3	4	5	6	7	8
BLG Series								
BLG-4000 Series	○	○	—	—	○	—	○	○
BLG-5000 Series	○	○	—	—	○	—	○	○

Model	1	2	3	4	5	6	7	8
OPC screwdrivers supporting OPC Screw Counter								
BLG-4000 Series -OPC	○	○	—	—	○	—	○	○
BLG-5000 Series -OPC	○	○	—	—	○	—	○	○

Model	1	2	3	4	5	6	7	8
BL Series								
BL-2000	○	○	—	—	○	—	○	○
BL-3000	—	○	—	—	—	○	○	○
BL-5000 Series	○	○	—	—	○	—	○	○
BL-5020	○	—	—	—	—	○	○	○
BL-7000X	○	—	—	—	—	○	○	○
BL-7000	○	○	—	—	—	○	○	○

Model	1	2	3	4	5	6	7	8
OPC screwdrivers supporting OPC Screw Counter								
BL-2000-OPC	○	—	—	—	○	—	○	○
BL-3000-OPC	—	—	—	—	—	○	○	○
BL-5000-OPC	—	—	—	—	—	○	○	○
BL-5020-OPC	—	—	—	—	—	○	○	○
BL-7000-OPC	—	—	—	—	—	○	○	○

Model	1	2	3	4	5	6	7	8
ESD anti-electrostatic								
BL-3000ESD	—	—	—	—	○	—	○	○
BL-5000ESD	○	—	—	—	○	—	○	○
BL-7000ESD	○	—	—	—	○	—	○	○

Model	1	2	3	4	5	6	7	8
Q-ESD suction & anti-electrostatic								
BLQ-ESD Series	○*	—	—	—	○	—	○	○

Model	1	2	3	4	5	6	7	8
Suction & clean room								
BLQ-CR Series	○*	—	—	—	—	—	○	○

Model	1	2	3	4	5	6	7	8
Q-CR-ESD clean room & anti-electrostatic								
BLQ-CR-ESD Series	○*	—	—	—	○	—	○	○

* Except for 3000 Series.

Model	1	2	3	4	5	6	7	8
PG Series								
PG-3000	—	—	—	—	—	○	○	○
PG-5000	—	—	—	—	—	○	○	○
PG-7000	—	—	—	—	—	○	○	○

Model	1	2	3	4	5	6	7	8
100V								
VB Series (Lever ST)								
VB-1510	—	○	—	—	—	○	○	○
VB-1510-18	—	—	—	—	—	○	○	○
VB-2008	—	—	—	—	—	○	○	○
VB-1820	—	○	—	—	—	○	○	○
VB-3012	—	○	—	—	—	○	○	○
VB-3020	—	—	—	—	—	○	○	○
VB-4504	—	○	—	—	—	○	○	○
VBH-1820	—	—	—	—	—	○	○	○
VBH-3012	—	—	—	—	—	○	○	○

Model	1	2	3	4	5	6	7	8
VB Series (Push ST)								
VB-1510PS	—	○	—	—	—	○	○	○
VB-1510-18PS	—	—	—	—	—	○	○	○
VB-1820PS	—	○	—	—	—	○	○	○
VB-2008PS	—	—	—	—	—	○	○	○
VB-3012PS	—	○	—	—	—	○	○	○
VB-3020PS	—	—	—	—	—	○	○	○
VB-4504PS	—	○	—	—	—	○	○	○
VBH-1820PS	—	—	—	—	—	○	○	○
VBH-3012PS	—	—	—	—	—	○	○	○
OPC screwdrivers supporting OPC Screw Counter								
VB-OPC Series	—	—	—	—	—	○	○	○
VBH-OPC Series	—	—	—	—	—	○	○	○

Model	1	2	3	4	5	6	7	8
120V								
VB Series (Lever ST)								
VB-1510	—	—	—	—	—	○	○	○
VB-1510-18	—	—	—	—	—	○	○	○
VB-1820	—	—	—	—	—	○	○	○
VB-3012	—	—	—	—	—	○	○	○
VB-4504	—	—	—	—	—	○	○	○
VB-1510PS	—	—	—	—	—	○	○	○
VBH-1820	—	—	—	—	—	○	○	○
VBH-3012	—	—	—	—	—	○	○	○

Model	1	2	3	4	5	6	7	8
VB Series (Push ST)								
VB-1510-18PS	—	—	—	—	—	○	○	○
VB-1820PS	—	—	—	—	—	○	○	○

Model	1	2	3	4	5	6	7	8
VB-3012PS	—	—	—	—	—	○	○	○
VB-4504PS	—	—	—	—	—	○	○	○
VBH-1820PS	—	—	—	—	—	○	○	○
VBH-3012PS	—	—	—	—	—	○	○	○

Model	1	2	3	4	5	6	7	8
OPC screwdrivers supporting OPC Screw Counter								
VB-OPC Series	—	—	—	—	—	○	○	○
VBH-OPC Series	—	—	—	—	—	○	○	○

Model	1	2	3	4	5	6	7	8
220-240V								
VB Series (Lever ST)								
VB-1510	—	—	—	—	—	○	○	○
VB-1510-18	—	—	—	—	—	○	○	○
VB-1820	○	○	—	—	—	○	○	○
VB-3012	○	○	—	—	—	○	○	○
VB-4504	○	○	—	—	—	○	○	○
VBH-1820	○	—	—	—	—	○	○	○
VBH-3012	○	—	—	—	—	○	○	○

Model	1	2	3	4	5	6	7	8
VB Series (Push ST)								
VB-1510PS	—	—	—	—	—	○	○	○
VB-1510-18PS	—	—	—	—	—	○	○	○
VB-1820PS	○	○	—	—	—	○	○	

Cautions

- Different order code system applies to China CQC mark certified products. Please contact the HIOS distributor before ordering.
- For the GB Safety Standard(UKCA), please contact the HIOS distributor.

5	6	7	8
ESD	ESD	RoHS	10
Anti-electrostatic IEC61340 compliant products	Supporting anti-electrostatic (Surface resistance: 3 x 10 ¹² Ω or less)	RoHS compliant products	China RoHS compliant products

Model	1	2	3	4	5	6	7	8
VZH-1820PS	—	—	—	—	—	○	○	○
VZH-3012PS	—	—	—	—	—	○	○	○
OPC screwdrivers supporting OPC Screw Counter								
VZ-OPC Series	—	—	—	—	—	○	○	○
VZH-OPC Series	—	—	—	—	—	○	○	○

220-240V

VZ Series (Lever ST)

VZ-1812	—	○	—	—	—	○	○	○
VZ-3007	—	○	—	—	—	○	○	○
VZ-4504	—	○	—	—	—	○	○	○

VZ Series (Push ST)

VZ-1812PS	—	○	—	—	—	○	○	○
VZ-3007PS	—	○	—	—	—	○	○	○
VZ-4504PS	—	○	—	—	—	○	○	○

OPC screwdrivers supporting OPC Screw Counter

VZ-OPC Series	—	—	—	—	—	○	○	○
---------------	---	---	---	---	---	---	---	---

Electric Tapper

BL-5000SB	○	—	—	—	—	○	○	○
BL-7000SB	○	—	—	—	—	○	○	○
SB-400C	—	—	—	—	—	○	○	○
SB-650C	—	—	—	—	—	○	○	○

Controller for SB Series

SBC-1	—	—	—	—	—	○	○	○
-------	---	---	---	---	---	---	---	---

Automatic Screw Feeder

HSV Series	—	—	—	—	—	○	○	○
HSV-RB Series	—	—	—	—	—	○	○	○
HS Series	—	—	—	—	—	○	○	○
HS-RB Series	—	—	—	—	—	○	○	○
HSIII Series	—	—	—	—	—	○	○	○
HSIII-RB Series	—	—	—	—	—	○	○	○
HSF Series	—	—	—	—	—	○	○	○

AC Adaptor

HS-AD (AC100V)	—	—	—	—	—	○	○	○
HS-AD220 (AC220V)	○	—	○	—	—	○	○	○

Torque Meter

HP-100	○	—	—	—	—	○	○	○
HP-10	○	—	—	—	—	○	○	○
HP-1	○	—	—	—	—	○	○	○
HDP-50	○	—	—	—	—	○	○	○
HDP-5	○	—	—	—	—	○	○	○
HDP-100	○	—	—	—	—	○	○	○
HM-10	—	—	—	—	—	○	○	○
HM-100	—	—	—	—	—	○	○	○
HIT-200	—	—	—	—	—	○	○	○
HIT-500	—	—	—	—	—	○	○	○
HIT-1000	—	—	—	—	—	○	○	○

Fidaptor (HP Series / HM Series)

Fidaptor	—	—	—	—	—	○	○	○
----------	---	---	---	---	---	---	---	---

Battery Charger for HP / HDP Series

TCH-MULTI	—	—	—	○	—	○	○	○
TCH-MULTI-CN	—	○	—	—	—	○	○	○
TCH-MULTI-CE	○	—	—	—	—	○	○	○

Model	1	2	3	4	5	6	7	8
Battery Charger for HM / HIT Series								
TCH-100N	—	—	—	—	—	○	○	○
TCH-120N	—	—	—	○	—	○	○	○
TCH-230G	○	—	—	—	—	○	○	○

Power Supply for DC Screwdrivers

T-45BL	○	—	○	○	○	—	○	○
T-70BL	○	—	○	○	○	—	○	○
T-80BL	○	—	○	○	—	○	○	○
CLT-45	○	—	○	○	○	—	○	○
CLT-60	○	—	○	○	○	—	○	○
CLT-80	○	—	○	○	—	○	○	○

Power Supply for Screwdrivers for Automated Machines

BLT-AY-61	○	—	—	—	—	○	○	○
BLT-AY-71	○	—	—	—	—	○	○	○
CLT-AY-61 (AC100V)	—	—	—	—	—	○	○	○
CLT-AY-61 (AC120V)	—	—	—	—	—	○	○	○
CLT-AY-61 (AC220V)	—	—	—	—	—	○	○	○
CLT-AY-81 (AC100V)	—	—	—	—	—	○	○	○

Screw Counter

BLOP-STC3	○	—	—	—	—	○	○	○
CLT-70STC3	○	—	—	—	—	○	○	○
VZOP-STC	—	—	—	—	—	○	○	○
BLOP-SC1	—	—	—	—	—	○	○	○
CLOP-SC1	—	—	—	—	—	○	○	○

PGF Series

PGF-3000	—	—	—	—	—	○	○	○
PGF-5000	—	—	—	—	—	○	○	○
PGF-7000	—	—	—	—	—	○	○	○

Q suction

PGFQ Series	—	—	—	—	—	○	○	○
-------------	---	---	---	---	---	---	---	---

For fastening in FR deep recessed holes

PGFR Series	—	—	—	—	—	○	○	○
-------------	---	---	---	---	---	---	---	---

BLF Series

BLF-2000	○	—	—	—	—	○	○	○
BLF-5000	○	—	—	—	—	○	○	○
BLF-7000	○	—	—	—	—	○	○	○
BLF-7000X	○	—	—	—	—	○	○	○
BLF-7025X	○	—	—	—	—	○	○	○

Q suction

BLFQ Series	○	—	—	—	—	○	○	○
-------------	---	---	---	---	---	---	---	---

For fastening in FR deep recessed holes

BLFR Series	○	—	—	—	—	○	○	○
-------------	---	---	---	---	---	---	---	---

CLF / aF Series

CLF-3000	—	—	—	—	—	○	○	○
CLF-4000*	—	—	—	—	—	○	○	○
CLF-6000*	—	—	—	—	—	○	○	○
CLF-6500*	—	—	—	—	—	○	○	○
CLF-7000*	—	—	—	—	—	○	○	○

Q suction

CLFQ Series	—	—	—	—	—	○	○	○
-------------	---	---	---	---	---	---	---	---

* The noiseless type is CE certified.

CL-A Series

CL-816A	—	—	—	—	—	○	○	○
CL-825A	—	—	—	—	—	○	○	○
CL-850A	—	—	—	—	—	○	○	○

Model	1	2	3	4	5	6	7	8
aF Series								
aF-4000	○	—	—	—	—	○	○	○
aF-6000	○	—	—	—	—	○	○	○
aF-6500	○	—	—	—	—	○	○	○
Q suction								
aFQ Series	○	—	—	—	—	○	○	○

Recipro Series RN53

RD-4000	—	—	—	—	—	○	○	○
RD-4500	—	—	—	—	—	○	○	○
RD-10	—	—	—	—	—	○	○	○
RD-15	—	—	—	—	—	○	○	○
RD-20	—	—	—	—	—	○	○	○
RD-30	—	—	—	—	—	○	○	○

Power Supply

RDT-30 (AC100V)	—	—	—	—	—	○	○	○
RAC-100 (AC100V)	—	—	—	—	—	○	○	○

Linear Feeder

FF503H (AC100V)	—	—	—	—	—	○	○	○
-----------------	---	---	---	---	---	---	---	---

Screwdriver Cord

Screwdriver cord	—	—	—	—	—	○	○	○
Flexible cord	—	—	—	—	—	○	○	○
Curled cord	—	—	—	—	—	○	○	○
Extension cord	—	—	—	—	—	○	○	○

Spike Bit

SPK Series	—	—	—	—	—	○	○	○
------------	---	---	---	---	---	---	---	---

Vacuum Pump

VP-3 (AC100V)	—	—	—	—	—	○	○	○
VP-3 (AC120V)	—	—	—	—	—	○	○	○
VP-3 (AC220V)	○	—	—	—	—	○	○	○

Aluminum Handle Screwdriver

WOOD-4AL	—	—	—	—	—	○	○	○
WOOD-5	—	—	—	—	—	○	○	○

Grip Ring

Grip Ring	—	—	—	—	—	○	○	○
-----------	---	---	---	---	---	---	---	---

Vertical Screwdriver Operating Stand

VMS-40	—	—	—	—	—	○	○	○
VMS-50	—	—	—	—	—	○	○	○
VMS-50VZ	—	—	—	—	—	○	○	○

Carbon Brush

Carbon Brush	—	—	—	—	—	○	○	○
--------------	---	---	---	---	---	---	---	---

Relay Box

BLOP-AF	—	—	—	—	—	○	○	○
BOLP-OST2	—	—	—	—	—	○	○	○

Bit for Exchange

Bit for Exchange	—	—	—	—	—
------------------	---	---	---	---	---

Electric Screwdriver Bit for Exchange

There are three drive types: HIOS Shank, two-way Shank and HEX Shank.
If your screwdriver uses HIOS Shank, please use a HIOS standard bit.

Screwdriver Bit Drive

Unit: mm

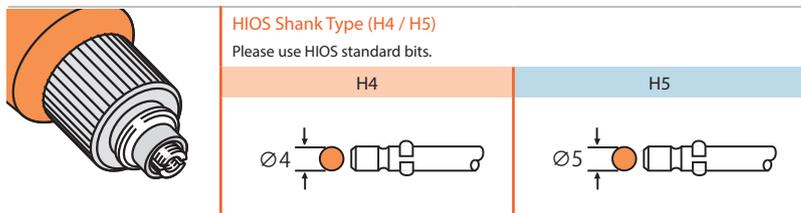

Compatible Bits by Model Quick Reference Chart

DC Type		Bit Drive	
Classification	Model	H4	H5
Brushless	BLG-4000 Series	●	—
	BLG-BC2 Series	●	●
	BLG-BC1 Series	●	●
	BLG-ZERO1 Series	—	●
	BLG Series	—	●
	PG Series	●	—
	PG Series	PG-3000	●
Brushless	BL Series	●	—
	BL Series	●	—
	BL Series	●	●
	BL Series	●	●
	BL Series	●	●
	BL Series	●	●
	BL Series	●	●
Brushed	CL Series	●	—
	CL Series	●	—
	CL Series	●	—
	CL Series	—	●
	CL Series	—	●
	CL Series	—	●
	CL Series	—	●
	CL Series	—	●
	CL Series	—	—
	CL Series	—	—

(These models include the push-to-start type.)

AC Type		Bit Drive	
Classification	Model	H4	H5
Brushless	VB Series	●	●
	VB Series	●	●
	VB Series	—	●
	VB Series	—	●
	VB Series	—	—
	VB Series	—	●
	VB Series	—	—
	VB Series	—	—
	VB Series	—	—
	VB Series	—	—
Brushed	VZ Series	●	—
	VZ Series	—	●
	VZ Series	—	●
	VZ Series	—	●
	VZ Series	—	—
	VZ Series	—	—
	VZ Series	—	—
	VZ Series	—	—

(These models include the push-to-start type.)

How to Fill in the Order Form

Please fill in the form while referring to the items in the specification table on the right.

Bit for Cross Screws

BP - H4 - #1 - 3.0 - 40mm

Bit Shape Bit drive Tip No. Tip dia. Total length

Bit for Slotted Head Screws

BS - H4 - 3.0 - 0.4 - 40mm

Bit Shape Bit drive Blade width Blade thickness Total length

Bit for Hexagon Socket Head Screws

BH - H4 - 1.5 - 60mm

Bit Shape Bit drive Nut width across flat Total length

Bit for Nut Boxes

BN - H4 - 2.3 - 40mm

Bit Shape Bit drive Nut width across flat Total length

Bit for Nut Catches

BC - H4 - 4.5 - 60mm

Bit Shape Bit drive Nut width across flat Total length

* Please note that minimum order unit of standard bits is 10 pieces per type.

Bit shape BP Bit for Cross Screws		Bit Drive	Tip No. (cross screw diameter)	Tip Diameter (φ)	Shaft Shape	Total Length (mm) Standard
	<p>(Shaft shape) Straight (A)</p> <p>Stepped (B)</p> <p>Stepped (C)</p>	H4	#00 (HIOS Standard)	1.5	B	40, 60, 80
			#0* (M1.4-M2.6)	1.2	B	40
				1.5, 1.7	B	40, 60, 80
				1.8	B	60, 80
				2.0, 2.5	B	40, 60, 80, 100, 120
			H5	#1 (M2.0-M2.6)	3.0	B
		4.0			A	40, 60, 80, 100, 120, 150, 180, 200
		4.0			A	40, 60, 80, 100, 120, 150
		#2 (M3.0-M5.0)		2.0	B	60
				2.5	B	60, 80, 100, 120
				3.0	B	40, 60, 80, 100, 120
		#3 (M6.0-M8.0)	5.0	A	40, 60, 80, 100, 120, 150, 180, 200, 250, 300	
5.0	A		40, 60, 80, 100, 120, 150, 180, 200, 250, 300, 400			
7.0	C		60, 80, 100, 120			

Dimensions of Stepped Bit (B)				
Bit drive	H4	H5		
(a) Tip diameter φ	Each size	2.0	2.5	3.0
(b) Length mm	20	20	25	30*

* Only for (H5) - (#1) - (3.0 x 40mm), the length of the stepped section is 15 mm.

* Applicable to low-profile screws.

Bit shape BS Bit for Slotted Head Screws		Bit Drive	Blade Width (mm)	Blade Thickness	Shaft Shape	Total Length (mm) Standard
	<p>(Shaft shape) Straight (A)</p> <p>Stepped (B)</p> <p>Stepped (C)</p>	H4	1.1	0.28	B	60, 80
			1.3	0.28	B	60, 80
			1.5	0.3	B	40, 60, 80
			1.7	0.3	B	40, 60, 80
			1.8	0.4	B	60, 80
			2.0	0.4	B	40, 60, 80
			2.3	0.4	B	60, 80
			2.5	0.4	B	40, 60, 80
			2.8	0.4	B	60, 80
			3.0	0.4	B	40, 60, 80
		4.0	0.6	A	40, 60, 80, 100	
		H5	2.0	0.4	B	60
			2.5	0.4	B	60
			3.0	0.4	B	60, 80
			4.0	0.6	B	60
			5.0	0.7	A	60, 80, 100, 120, 150, 180
			7.0	1.0	C	60

Dimensions of Stepped Bit (B)					
Bit drive	H4	H5			
(a) Blade width mm	Each size	2.0	2.5	3.0	4.0
(b) Length mm	20	20	25	20	30

Bit shape BH Bit for Hexagon Socket Head Screws		Bit Drive	Nut Width Across Flat (mm)	Total Length (mm) Standard
<p>For hexagon socket set screws and cap screws</p> <p>(A) Hex wrench pressed in type</p>	H4	0.89, 1.5, 2.0, 3.0	60	
		1.27	60, 100	
		2.5	60, 100, 120	
	H5	1.27	70	
		1.5, 3.0, 4.0, 6.0	70, 100	
		2.0, 2.5, 5.0	70, 100, 120	

HEX 0.89 mm and 1.27 mm are A-type only. / HEX 1.5 mm is applicable to both types. (How to order) Example: BH-H4 or H5-1.5(A) x 60 mm

Bit shape BN Bit for Nut Box (Hexagonal Nut)		Bit Drive	Nut Width Across Flat (mm)	Total Length (mm) Standard
<p>For bolts & nuts</p>	H4	2.3, 2.5, 3.0	40	
		4.0, 4.5, 5.0, 5.5, 6.0, 7.0, 8.0, 9.0	60	
		10.0	60	
	H5	4.0, 4.5, 5.0, 5.5, 6.0, 6.35	60	
		7.0, 8.0	80	
		9.0, 10.0, 11.0, 12.0, 13.0, 14.0, 17.0	80	

Bit shape BC Bit for Nut Catch (for Picking Up)		Bit Drive	Nut Width Across Flat (mm)	Total Length (mm) Standard
<p>For bolts & nuts</p>	H4	4.0, 4.5, 5.0, 5.5, 6.0, 7.0	60	
		8.0	65	
	H5	4.0, 4.5, 5.0, 5.5, 6.0, 7.0	60	
		8.0	65	

Electric Screwdriver Bit for Exchange (Hexalobular)

The bit drive of this model is HIOS Shank type.

For the screwdriver with HIOS shank, please use HIOS standard bit.

Screwdriver Bit Drive

Unit: mm



HIOS Shank Type (H4 / H5)

Please use HIOS standard bits.

H4



H5



Compatible spec: [P.56](#)

TX	Hexalobular	Bit Drive	Name	P/N	Dimensions (mm)								
					A	D	L						
		H4	H4 HW T3(1.7)×60	TX403060	1.1	1.7	60						
			H4 HW T4(1.8)×60	TX404060	1.3	1.8	60						
			H4 HW T5(2.0)×60	TX405060	1.4	2.0	60						
			H4 HW T6(2.5)×60	TX406060	1.7	2.5	60						
			H4 HW T8(3.0)×60	TX408060	2.3	3.0	60						
		H4	H4 HW T10(4.0)×60	TX410060	2.7	4.0	60						
				H5	H5 HW T8 (3.0)×80	TX508080	2.3	3.0	80				
						H5	H5 HW T10 (5.0)×80	TX510080	2.7	5.0	80		
							H5 HW T20 (5.0)×80	TX520080	3.8	5.0	80		
							H4	H4 HWT8H(3.0)×60	TX408060H	2.3	3.0	60	
	H4	H4 HW T10H (4.0)×60						TX410060H	2.7	4.0	60		
			H5	H5 HW T8H (3.0)×80				TX508080H	2.3	3.0	80		
								H5	H5 HW T10H (5.0)×80	TX510080H	2.7	5.0	80
									H5 HW T20H (5.0)×80	TX520080H	3.8	5.0	80

Electric Screwdriver Bit for Exchange (TORX® & TORX PLUS®)

TORX®, TORX PLUS® Screwdriver bits are available on request.
For different specifications, please contact HIOS distributors.

Screwdriver Bit Drive

Unit: mm



HIOS Shank Type (H4 / H5)
Please use HIOS standard bits.

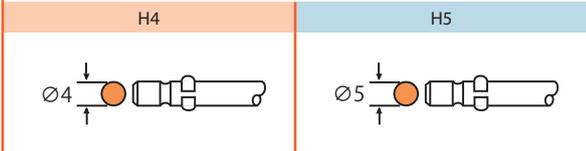

Compatible spec: [P.56](#) →

TORX®	For TORX® Screw	Bit Drive	Drive	Name	P/N	Dimensions (mm)			
						A	D	B	L
		H4	T3	TORX-H4-T3-X-()	TORX403()	1.12	1.7	20	40, 60, 80, 100, 120
			T4	TORX-H4-T4-X-()	TORX404()	1.30	1.8	20	
			T5	TORX-H4-T5-X-()	TORX405()	1.37	2.0	20	
			T6	TORX-H4-T6-X-()	TORX406()	1.65	2.5	20	
			T8	TORX-H4-T8-X-()	TORX408()	2.30	3.0	20	
			T10	TORX-H4-T10-X-()	TORX410()	2.72	3.0	20	
	*H5-T25	H5	T8	TORX-H5-T8-X-()	TORX508()	2.30	3.0	20	40, 60, 80, 100, 120
			T10	TORX-H5-T10-X-()	TORX510()	2.72	3.0	20	
			T15	TORX-H5-T15-X-()	TORX515()	3.26	3.5	20	
			T20	TORX-H5-T20-X-()	TORX520()	3.84	4.0	20	
			T25*	TORX-H5-T25-X-()	TORX525()	4.40	5.0	—	
	For TORX PLUS® Screw	H4	4IP	TORX PLUS H4-4IP-X-()	TORX404IP()	1.28	1.8	20	40, 60, 80, 100, 120
			5IP	TORX PLUS H4-5IP-X-()	TORX405IP()	1.40	2.0	20	
			6IP	TORX PLUS H4-6IP-X-()	TORX406IP()	1.68	2.5	20	
			8IP	TORX PLUS H4-8IP-X-()	TORX408IP()	2.29	3.0	20	
			10IP	TORX PLUS H4-10IP-X-()	TORX4010IP()	2.71	3.0	20	
	*H5-25IP	H5	8IP	TORX PLUS H5-8IP-X-()	TORX508IP()	2.29	3.0	20	40, 60, 80, 100, 120
			10IP	TORX PLUS H5-10IP-X-()	TORX510IP()	2.71	3.0	20	
			15IP	TORX PLUS H5-15IP-X-()	TORX515IP()	3.25	3.5	20	
			20IP	TORX PLUS H5-20IP-X-()	TORX520IP()	3.83	4.0	20	
			25IP*	TORX PLUS H5-25IP-X-()	TORX525IP()	4.39	5.0	—	

The () in the Part No. will be 3 digits.
ex. TORX-H4-T3X60 → TORX403060
ex. TORX-H4-T3X100 → TORX403100

The () in the Name means total length (L) of bit.

BLG-BC2 P.11

Model	Order Code	Bit Drive
-------	------------	-----------

Lever Start

BLG-4000BC2	BLG-4000BC2	H4
	BLG-4000XBC2	1/4HEX
BLG-4000BC2-LT	BLG-4000BC2-LT	H4

Lever Start and Push-to-Start

	BLG-5000BC2	H4
BLG-5000BC2	BLG-5000H5BC2	H5 and 5HEX
	BLG-5000X5BC2	H5 and 5HEX
	BLG-5000XBC2	1/4HEX
	BLG-5000BC2-15	H4
BLG-5000BC2-15	BLG-5000H5BC2-15	H5 and 5HEX
	BLG-5000X5BC2-15	H5 and 5HEX
	BLG-5000XBC2-15	1/4HEX
	BLG-5000BC2-18	H5 and 5HEX
BLG-5000BC2-18	BLG-5000X5BC2-18	H5 and 5HEX
	BLG-5000XBC2-18	1/4HEX
	BLG-5000BC2-HT	H5 and 5HEX
BLG-5000BC2-HT	BLG-5000XBC2-HT	1/4HEX
	BLG-7000BC2	H5 and 5HEX
BLG-7000BC2	BLG-7000XBC2	1/4HEX
BLG-7000BC2-GT	Please inquire	1/4HEX

Dedicated Cable for External I/O

BLG-BC2-3012	BLG-BC2-3012	One-touch Type
BLG-BC2-3010	BLG-BC2-3010	Phone Plug Type

External I/O Box

BLG-IO-Pro1	BLG-IO-Pro1	—
-------------	-------------	---

Serial-to-Parallel Conversion Box

BLG-IF2	BLG-IF2	—
---------	---------	---

BLG-BC2 Variations P.12

Q Suction

If you wish to purchase a suction part, please select the screwdriver and the suction unit (suction attachment, mouthpiece and bit) on P. 51 before ordering.

BLG-BC1 P.13

Model	Order Code	Bit Drive
-------	------------	-----------

Lever Start

BLG-4000BC1	BLG-4000BC1	H4
	BLG-4000XBC1	1/4HEX

Lever start and Push-to-Start

	BLG-5000BC1	H4
BLG-5000BC1	BLG-5000H5BC1	H5 and 5HEX
	BLG-5000XBC1	1/4HEX
	BLG-5000BC1-15	H4
BLG-5000BC1-15	BLG-5000H5BC1-15	H5 and 5HEX
	BLG-5000XBC1-15	1/4HEX

Model	Order Code	Bit Drive
-------	------------	-----------

Lever Start and Push-to-Start

BLG-5000BC1-18	BLG-5000BC1-18	H5 and 5HEX
	BLG-5000XBC1-18	1/4HEX
BLG-5000BC1-HT	BLG-5000BC1-HT	H5 and 5HEX
	BLG-5000XBC1-HT	1/4HEX

BLG-BC1 Variations P.14

Q Suction

If you wish to purchase a suction part, please select the screwdriver and the suction part (suction attachment, mouthpiece and bit) on P. 51 before ordering.

BLG-ZERO1 P.13

Model	Order Code	Bit Drive
-------	------------	-----------

Lever Start

BLG-4000ZERO1	BLG-4000ZERO1	H4
	BLG-4000XZERO1	1/4HEX

Lever Start and Push-to-Start

	BLG-5000ZERO1	H4
BLG-5000ZERO1	BLG-5000H5ZERO1	H5 and 5HEX
	BLG-5000XZERO1	1/4HEX
	BLG-5000ZERO1-15	H4
BLG-5000ZERO1-15	BLG-5000H5ZERO1-15	H5 and 5HEX
	BLG-5000XZERO1-15	1/4HEX
	BLG-5000ZERO1-18	H5 and 5HEX
BLG-5000ZERO1-18	BLG-5000XZERO1-18	1/4HEX
	BLG-5000ZERO1-HT	H5 and 5HEX
BLG-5000ZERO1-HT	BLG-5000XZERO1-HT	1/4HEX

BLG-ZERO1 Variations P.14

Q Suction

If you wish to purchase a suction part, please select the screwdriver and the suction unit (suction attachment, mouthpiece and bit) on P. 51 before ordering.

BLG P.13

Model	Order Code	Bit Drive
-------	------------	-----------

Lever Start

BLG-4000	BLG-4000BC1	H4
	BLG-4000X	1/4HEX

Lever Start and Push-to-Start

	BLG-5000	H4
BLG-5000	BLG-5000H5	H5 and 5HEX
	BLG-5000X	1/4HEX
	BLG-5000-15	H4
BLG-5000-15	BLG-5000H5-15	H5 and 5HEX
	BLG-5000X-15	1/4HEX
	BLG-5000-18	H5 and 5HEX
BLG-5000-18	BLG-5000X-18	1/4HEX
	BLG-5000-HT	H5 and 5HEX
BLG-5000-HT	BLG-5000X-HT	1/4HEX

BLG Variations P.14

Q Suction

If you wish to purchase a suction part, please select the screwdriver and the suction unit (suction attachment, mouthpiece and bit) on P. 51 before ordering.

OPC Screwdrivers Supporting Screw Counters

Model	Order Code	Bit Drive
-------	------------	-----------

Lever Start

BLG-4000-OPC	BLG-4000-OPC	H4
	BLG-4000X-OPC	1/4HEX

Lever Start and Push-to-Start

	BLG-5000-OPC	H4
BLG-5000-OPC	BLG-5000H5-OPC	H5 and 5HEX
	BLG-5000X5-OPC	H5 and 5HEX
	BLG-5000X-OPC	1/4HEX
	BLG-5000-OPC15	H4
BLG-5000-OPC-15	BLG-5000H5-OPC-15	H5 and 5HEX
	BLG-5000X5-OPC15	H5 and 5HEX
	BLG-5000X-OPC15	1/4HEX
BLG-5000-OPC-18	BLG-5000-OPC-18	H5 and 5HEX
	BLG-5000X-OPC18	1/4HEX
BLG-5000-OPCHT	BLG-5000-OPCHT	H5 and 5HEX
	BLG-5000X-OPCHT	1/4HEX

PG P.15

Model	Order Code	Bit Drive
-------	------------	-----------

Lever Start

PG-3000	PG-3000	H4
PG-5000	PG-5000	H4
PG-7000	PG-7000	H5 and 5HEX
	PG-7000X	1/4HEX

Control Unit

PG-01	PG-01	—
-------	-------	---

PG Variations P.16

Q Suction

If you wish to purchase a suction part, please select the screwdriver and the suction unit (suction attachment, mouthpiece and bit) on P. 51 before ordering.

BL P.17

Model	Order Code	Bit Drive
-------	------------	-----------

Lever Start

BL-2000	BL-2000	H4
BL-2000SS	BL-2000SS	H4

Lever Start and Push-to-Start

BL-3000	BL-3000	H4
	BL-3000X	1/4HEX
BL-3000SS	BL-3000SS	H4
	BL-3000SSX	1/4HEX
	BL-5000	H4
BL-5000	BL-5000H5	H5 and 5HEX
	BL-5000X	1/4HEX

Model	Order Code	Bit Drive
BL-5000SS	BL-5000SS	H4
	BL-5000SS-H5	H5 and 5HEX
	BL-5000SSX	1/4HEX
BL-5000-15	BL-5000-15	H4
	BL-5000H5-15	H5 and 5HEX
	BL-5000X-15	1/4HEX
BL-5020	BL-5020	H5 and 5HEX
	BL-5020X	1/4HEX
BL-7000	BL-7000	H5 and 5HEX
	BL-7000X	1/4HEX

BL Variations P.18

Q Suction

If you wish to purchase a suction part, please select the screwdriver and the suction unit (suction attachment, mouthpiece and bit) on P. 51 before ordering.

Q-ESD Anti-electrostatic Suctions

BLQ-ESD has a suction attachment as standard, but doesn't include a mouthpiece and a bit. Please select them on P. 51 before ordering.

Model	Order Code	Bit Drive
-------	------------	-----------

Lever Start and Push-to-Start

BLQ-3000ESD	BLQ-3000ESD	H4
BLQ-5000ESD	BLQ-5000ESD	H4
	BLQ-5000H5-ESD	H5 and 5HEX
BLQ-5000ESD-15	BLQ-5000ESD-15	H4
	BLQ-5000H5-ESD-15	H5 and 5HEX
BLQ-7000ESD	BLQ-7000ESD	H5 and 5HEX

Q-CR for Clean Room

BLQ-CR has a suction attachment as standard, but doesn't include a mouthpiece and a bit. Please select them on P. 51 before ordering.

Model	Order Code	Bit Drive
-------	------------	-----------

Lever Start

BLQ-2000CR	BLQ-2000CR	H4
------------	------------	----

Lever Start and Push-to-Start

BLQ-3000CR	BLQ-3000CR	H4
BLQ-5000CR	BLQ-5000CR	H4
	BLQ-5000H5-CR	H5 and 5HEX
BLQ-5000CR-15	BLQ-5000CR-15	H4
	BLQ-5000H5-CR-15	H5 and 5HEX
BLQ-7000CR	BLQ-7000CR	H5 and 5HEX

ESD Anti-electrostatic

Model	Order Code	Bit Drive
-------	------------	-----------

Lever Start and Push-to-Start

BL-3000ESD	BL-3000ESD	H4
	BL-3000X-ESD	1/4HEX
	BL-5000ESD	H4
BL-5000ESD	BL-5000H5-ESD	H5 and 5HEX
	BL-5000X-ESD	1/4HEX
	BL-5000ESD-15	H4
BL-5000ESD-15	BL-5000X5-ESD-15	H5 and 5HEX
	BL-5000XESD-15	1/4HEX

Model	Order Code	Bit Drive
BL-5020ESD	BL-5020-ESD	H5
	BL-5020X-ESD	1/4HEX
BL-7000ESD	BL-7000ESD	H5 and 5HEX
	BL-7000X-ESD	1/4HEX

Q-CR-ESD for Clean Room / Anti-electrostatic

BLQ-CR-ESD has a suction attachment as standard, but doesn't include a mouthpiece and a bit. Please select them on P. 51 before ordering. (Also applicable to BLQ-2000CR.)

Model	Order Code	Bit Drive
-------	------------	-----------

Lever Start

BLQ-2000CR	BLQ-2000CR	H4
------------	------------	----

Lever Start and Push-to-Start

BLQ-3000CR-ESD	BLQ-3000CR-ESD	H4
BLQ-5000CR-ESD	BLQ-5000CR-ESD	H4
	BLQ-5000H5-CR-ESD	H5 and 5HEX
BLQ-5000CR-ESD-15	BLQ-5000CR-ESD-15	H4
	BLQ-5000H5CR-ESD-15	H5 and 5HEX
BLQ-7000CR-ESD	BLQ-7000CR-ESD	H5 and 5HEX

OPC Screwdrivers Supporting Screw Counters

Model	Order Code	Bit Drive
-------	------------	-----------

Lever Start

BL-2000-OPC	BL-2000-OPC	H4
-------------	-------------	----

Lever Start and Push-to-Start

BL-3000-OPC	BL-3000-OPC	H4
	BL-3000X-OPC	1/4HEX
BL-5000-OPC	BL-5000-OPC	H4
	BL-5000H5-OPC	H5 and 5HEX
BL-5000-15OPC	BL-5000X-OPC	1/4HEX
	BL-5000-15OPC	H4
BL-5000-15OPC	BL-5000X5-OPC-15	H5 and 5HEX
	BL-5000X-OPC-15	1/4HEX
	BL-5020-OPC	H5 and 5HEX
BL-5020-OPC	BL-5020-OPC	H5 and 5HEX
	BL-5020X-OPC	1/4HEX
BL-7000-OPC	BL-7000-OPC	H5 and 5HEX
	BL-7000X-OPC	1/4HEX

BL Accessories P.18

Order Code	Applicable Model
------------	------------------

Pistol Attachment

PAB-70	BL-7000 Series
--------	----------------

CL P.19

Model	Order Code	Bit Drive
-------	------------	-----------

Lever Start

CL-2000	CL-2000	H4
CL-3000	CL-3000	H4
CL-4000	CL-4000	H4
	CL-4000X5	5HEX
	CL-4000X	1/4HEX
CL-6000	CL-6000	H5
	CL-6000X5	5HEX
	CL-6000X	1/4HEX

Model	Order Code	Bit Drive
CL-6500	CL-6500	H5
	CL-6500X5	5HEX
	CL-6500X	1/4HEX
CL-7000	CL-7000	H5
	CL-7000X5	5HEX
	CL-7000X	1/4HEX

Push-to-Start

CL-4000PS	CL-4000PS	H4
	CL-4000PS-X5	5HEX
	CL-4000PSX	1/4HEX
CL-6000PS	CL-6000PS	H5
	CL-6000PSX5	5HEX
	CL-6000PSX	1/4HEX
CL-6500PS	CL-6500PS	H5
	CL-6500PSX5	5HEX
	CL-6500PSX	1/4HEX
CL-7000PS	CL-7000PS	H5
	CL-7000PSX5	5HEX
	CL-7000PSX	1/4HEX
CL-9000	CL-9000	1/4HEX

CL Variations P.20

Q Suction

CLQ has a suction attachment as standard, but doesn't include a mouthpiece and a bit. Please select them on P. 51 before ordering.

Model	Order Code	Bit Drive
-------	------------	-----------

Lever Start

CLQ-2000	CLQ-2000	H4
CLQ-3000	CLQ-3000	H4
CLQ-4000	CLQ-4000	H4
CLQ-6000	CLQ-6000	H5
CLQ-6500	CLQ-6500	H5
CLQ-7000	CLQ-7000	H5

Push-to-Start

CLQ-4000PS	CLQ-4000PS	H4
CLQ-6000PS	CLQ-6000PS	H5
CLQ-6500PS	CLQ-6500PS	H5
CLQ-7000PS	CLQ-7000PS	H5

ESD Anti-electrostatic

Model	Order Code	Bit Drive
-------	------------	-----------

Lever Start

CL-2000ESD	CL-2000ESD	H4
CL-3000ESD	CL-3000ESD	H4
CL-4000ESD	CL-4000ESD	H4
	CL-4000X5-ESD	5HEX
	CL-4000X-ESD	1/4HEX
CL-6000ESD	CL-6000ESD	H5
	CL-6000X5-ESD	5HEX
	CL-6000X-ESD	1/4HEX
CL-6500ESD	CL-6500ESD	H5
	CL-6500X5-ESD	5HEX
CL-6500X-ESD	1/4HEX	

Order Codes

Model	Order Code	Bit Drive
	CL-7000ESD	H5
CL-7000ESD	CL-7000X5-ESD	5HEX
	CL-7000X-ESD	1/4HEX

Push-to-Start

	CL-4000PS-ESD	H4
CL-4000PSESD	CL-4000PSX5-ESD	5HEX
	CL-4000PSX-ESD	1/4HEX
	CL-6000PS-ESD	H5
CL-6000PSESD	CL-6000PSX5-ESD	5HEX
	CL-6000PSX-ESD	1/4HEX
	CL-6500PS-ESD	H5
CL-6500PSESD	CL-6500PSX5-ESD	5HEX
	CL-6500PSX-ESD	1/4HEX
	CL-7000PS-ESD	H5
CL-7000PSESD	CL-7000PSX5-ESD	5HEX
	CL-7000PSX-ESD	1/4HEX

Q-CR-ESD for Clean Room / Anti-electrostatic

CLQ-CR-ESD has a suction attachment as standard, but doesn't include a mouthpiece and a bit. Please select them on P.51 before ordering.

Model	Order Code	Bit Drive
	CLQ-2000CR-ESD	H4
CLQ-2000CR-ESD	CLQ-3000CR-ESD	H4
	CLQ-3000CR-ESD	H4
CLQ-4000CR-ESD	CLQ-4000CR-ESD	H4
	CLQ-4000CR-ESD	H4
CLQ-6000CR-ESD	CLQ-6000CR-ESD	H5
	CLQ-6000CR-ESD	H5
CLQ-6500CR-ESD	CLQ-6500CR-ESD	H5
	CLQ-6500CR-ESD	H5
CLQ-7000CR-ESD	CLQ-7000CR-ESD	H5

Push-to-Start

CLQ-6000PSCR-ESD	CLQ-6000PSCR-ESD	H5
CLQ-6500PSCR-ESD	CLQ-6500PSCR-ESD	H5
CLQ-7000PSCR-ESD	CLQ-7000PSCR-ESD	H5

NL Noiseless

Model	Order Code	Bit Drive
	CL-3000NL	H4
CL-3000NL	CL-4000NL	H4
	CL-4000NL	H4
CL-6000NL	CL-6000NL	H5
	CL-6000NL	H5
CL-6500NL	CL-6500NL	H5
	CL-6500NL	H5
CL-7000NL	CL-7000NL	H5

Push-to-start

CL-4000PSNL	CL-4000PSNL	H4
CL-6000PSNL	CL-6000PSNL	H5
CL-6500PSNL	CL-6500PSNL	H5
CL-7000PSNL	CL-7000PSNL	H5
CL-9000NL	CL-9000NL	1/4HEX

CL Accessories

P.20

Order Code	Applicable Model
------------	------------------

Pistol Attachment

PA-65	CL-6000, CL-6500, CL-7000 (Including Push-to-start type)
-------	---

Order Code	Applicable Model
------------	------------------

Angle Attachments

ANGL-Z*1	CL-6000, CL-6500, CL-7000 (Only for Lever start type)
ANGLX-Z*2	CL-6000X, CL-6500X, CL-7000X (Only for Lever start type)

Grip Attachments for Push-to-Start Type

PS-1	Applicable to CL-4000
PS-1-ESD*3	Applicable to CL-4000

*1 Applicable to HIOS Shank H5.

*2 Applicable to Hex Shank 1/4HEX.

*3 Anti-electrostatic.

Power Supplies for DC Screwdrivers

P.21

Model	Order Code	Plug & Note
-------	------------	-------------

Power Supplies for Brushless Screwdrivers

	T-45BL	A (100V)
	T-45BL-UL	A2 (120V)
T-45BL	T-45BL-TH	A3 (220-240V)
	T-45BL-EU-HK	C (220-240V)
	T-45BL-UK-SP	BF (220-240V)
	T-45BL-CN	S (220-240V)
	T-70BL	A (100V)
	T-70BL-UL	A2 (120V)
T-70BL	T-70BL-TH	A3 (220-240V)
	T-70BL-EU-HK	C (220-240V)
	T-70BL-UK-SP	BF (220-240V)
	T-70BL-CN	S (220-240V)
T-80BL	Please inquire	

Power Supplies for Brushed Screwdrivers

	CLT-45	A (100V)
	CLT-45-UL	A-2 (120V)
CLT-45	CLT-45-TH	A-3 (220-240V)
	CLT-45-EU-HK	C (220-240V)
	CLT-45-UK-SP	BF (220-240V)
	CLT-45-CN	S (220-240V)
	CLT-60	A (100V)
	CLT-60-UL	A-2 (120V)
CLT-60	CLT-60-TH	A-3 (220-240V)
	CLT-60-EU-HK	C (220V-240)
	CLT-60-UK-SP	BF (220-240V)
	CLT-60-CN	S (220-240V)
	CLT-80	A-1 (100V)
	CLT-80-UL	A-2 (120V)
CLT-80	CLT-80-TH	A-3 (220-240V)
	CLT-80-EU-HK	C (220-240V)
	CLT-80-UK-SP	BF (220-240V)
	CLT-80-CN	S (220-240V)

Dedicated Controllers for Brushless Screwdrivers for Automated Machines

	BLT-AY61E	A-1 (100V)
	BLT-AY61E-USA	A-2 (120V)
BLT-AY-61	BLT-AY61E-TH	A-3 (220-240V)
	BLT-AY61E-EUHK	C (220-240V)
	BLT-AY61E-UKSP	BF (220-240V)
	BLT-AY61E-CN	S (220-240V)

Model	Order Code	Plug & Note
	BLT-AY71E	A-1 (100V)
	BLT-AY71E-USA	A2 (120V)
BLT-AY-71	BLT-AY71E-TH	A3 (220-240V)
	BLT-AY71E-EUHK	C (220-240V)
	BLT-AY71E-UKSP	BF (220-240V)
	BLT-AY71E-CN	S (220-240V)

Dedicated Controllers for Brushed Screwdrivers for Automated Machines

	CLT-AY61	A-1 (100V)
	CLT-AY61-120	A-2 (120V)
CLT-AY-61	CLT-AY61-230VDE	A-3 (220-240V)
	CLT-AY61-230SP	C (220-240V)
	CLT-AY61-220RCH	BF (220-240V)

CLT-AY-61 Options

2WV	CLT-AY61-2WV	A-1 (100V)
REV	CLT-AY61REV	A-1 (100V)
2WV+REV	CLT-AY61-2WVREV	A-1 (100V)

Dedicated Controllers for Brushed Screwdrivers for Automated Machines

CLT-AY-81	CLT-AY81	A-1 (100V)
-----------	----------	------------

CLT-AY-81 Options

2WV	CLT-AY81-2WV	A-1 (100V)
REV	CLT-AY81REV	A-1 (100V)
2WV+REV	CLT-AY81-2WVREV	A-1 (100V)

VB (100V)

P.23

Model	Order Code	Bit Drive
-------	------------	-----------

Lever Start

	VB-1510	H4
VB-1510	VB-1510H5	H5 and 5HEX
	VB-1510X5	5HEX
	VB-1510X	1/4HEX
	VB-1510-18	H4
VB-1510-18	VB-1510H5-18	H5 and 5HEX
	VB-1510X5-18	5HEX
	VB-1510X-18	1/4HEX
	VB-1820	H5 and 5HEX
VB-1820	VB-1820X	1/4HEX
	VB-2008	H5 and 5HEX
VB-2008	VB-2008X	1/4HEX
	VB-3012	H5 and 5HEX
VB-3012	VB-3012X	1/4HEX
	VB-3020	H5 and 5HEX
VB-3020	VB-3020X	1/4HEX
VBH-1820	VBH-1820X	1/4HEX
VBH-3012	VBH-3012X	1/4HEX

Push-to-Start

	VB-1510PS	H4
VB-1510PS	VB-1510PSH5	H5 and 5HEX
	VB-1510PSX	5HEX
	VB1510PS-18	H4
VB-1510PS-18	VB-1510PSH5-18	H5 and 5HEX
	VB-1510PSX-18	1/4HEX
	VB-1820PS	H5 and 5HEX
VB-1820PS	VB-1820PSX	1/4HEX

Model	Order Code	Bit Drive
VB-2008PS	VB-2008PS	H5 and 5HEX
	VB-2008PSX	1/4HEX
VB-3012PS	VB-3012PS	H5 and 5HEX
	VB-3012PSX	1/4HEX
VB-3020PS	VB-3020PS	H5 and 5HEX
	VB-3020PSX	1/4HEX
VB-4504PS	VB-4504PSX-S	1/4HEX
VBH-1820PS	VBH-1820PSX	1/4HEX
VBH-3012PS	VBH-3012PSX	1/4HEX

VB (100V) Variations P.24

For 120V and 220-240V, please contact the HIOS distributor.

Q Suction

If you wish to purchase a suction part, please select the screwdriver and the suction unit (suction attachment, mouthpiece and bit) on P. 51 before ordering.

OPC Screwdrivers Supporting Screw Counters

Model	Order Code	Bit Drive
Lever Start		
VB-1510-OPC	VB-1510-OPC	H4
	VB-1510H5-OPC	H5 and 5HEX
VB-1510-18-OPC	VB-1510-18-OPC	H4
	VB-1510H5-18-OPC	H5 and 5HEX
VB-1820-OPC	VB-1820-OPC	H5 and 5HEX
	VB-1820X-OPC	1/4HEX
VB-3012-OPC	VB-3012-OPC	H5 and 5HEX
	VB-3012X-OPC	1/4HEX
VB-3020-OPC	VB-3020-OPC	H5 and 5HEX
	VB-3020X-OPC	1/4HEX
VBH-1820-OPC	VBH-1820X-OPC	1/4HEX
	VBH-3012-OPC	VBH-3012X-OPC
Push-to-Start		
VB-1510PS-OPC	VB-1510PS-OPC	H4
	VB-1510PSH5-OPC	H5 and 5HEX
	VB-1510PSX5-OPC	5HEX
	VB-1510PSX-OPC	1/4HEX
VB-1510PS-18-OPC	VB-1510PS-18-OPC	H4
	VB-1510PSH5-18-OPC	H5 and 5HEX
	VB-1510PSX5-18-OPC	5HEX
	VB-1510PSX-18-OPC	1/4HEX
VB-1820PS-OPC	VB-1820PS-OPC	H5 and 5HEX
	VB-1820PSX-OPC	1/4HEX
VB-3012PS-OPC	VB-3012PS-OPC	H5 and 5HEX
	VB-3012PSX-OPC	1/4HEX
VB-3020PS-OPC	VB-3020PS-OPC	H5 and 5HEX
	VB-3020PSX-OPC	1/4HEX
VB-4504PS-OPC	VB-4504PSX-S-OPC	1/4HEX
VBH-1820PS-OPC	VBH-1820PSX-OPC	1/4HEX
VBH-3012PS-OPC	VBH-3012PSX-OPC	1/4HEX

VB Accessories P.24

Model	Applicable Model
-------	------------------

Pistol Attachment

PAB-18	VB-1820, VB-3012, VB-3020
PAB-18PS	VB-1820PS, VB-3012PS, VB-3020PS

Angle Attachment

ANGLV-Z-CH1*1	VB-1820, VB-3012, VB-3020 (Only for Lever start type)
ANGLV-Z-XX1*2	VB-1820X, VB-3012X, VB-3020X (Only for Lever start type)

*1 Applicable to HIOS Shank H5 and 5HEX.

*2 Applicable to HEX Shank 1/4HEX.

VB (120V) P.25

Model	Order Code	Bit Drive
-------	------------	-----------

Lever Start

VB-1510	VB-1510-120	H4
	VB-1510X5-120	H5 and 5HEX
	VB-1510X-120	1/4HEX
VB-1510-18	VB-1510-18-120	H4
	VB-1510X5-18-120	H5 and 5HEX
	VB-1510X-18-120	1/4HEX
VB-1820	VB-1820-120	H5 and 5HEX
	VB-1820X-120	1/4HEX
VB-3012	VB-3012-120	H5 and 5HEX
	VB-3012-120	1/4HEX
VB-4504	VB-4504X-120	1/4HEX
VBH-1820	VBH-1820X-120	1/4HEX
VBH-3012	VBH-3012X-120	1/4HEX

Push-to-Start

VB-1510PS	VB-1510PS-120	H4
	VB-1510PSX5-120	H5 and 5HEX
	VB-1510PSX-120	1/4HEX
VB-1510PS-18	VB-1510PS-18-120	H4
	VB-1510PSX5-18-120	H5 and 5HEX
	VB-1510PSX-18-120	1/4HEX
VB-1820PS	VB-1820PS-120	H5 and 5HEX
	VB-1820PSX-120	1/4HEX
VB-3012PS	VB-3012PS-120	H5 and 5HEX
	VB-3012PSX-120	1/4HEX
VB-4504PS	VB-4504PSX-120-S	1/4HEX
VBH-1820PS	VBH-1820PSX-120	1/4HEX
VBH-3012PS	VBH-3012PSX-120	1/4HEX

VB (220-240V) P.25

Model	Order Code	Bit Drive
-------	------------	-----------

Lever Start

VB-1510	VB-1510-B	H4
	VB-1510X5-B	H5 and 5HEX
	VB-1510X-B	1/4HEX
	VB-1510XB-CE	1/4HEX

Model	Order Code	Bit Drive
VB-1510-18	VB-1510-18-B	H4
	VB-1510X5-18-B	H5 and 5HEX
	VB-1510X-18-B	1/4HEX
	VB-1510X-18B-CE	1/4HEX
	VB-1820-B	H5 and 5HEX
VB-1820	VB-1820X-B	1/4HEX
	VB-1820XB-CE	1/4HEX
VB-3012	VB-3012-B	H5 and 5HEX
	VB-3012X-B	1/4HEX
	VB-3012X-B-CE	1/4HEX
VB-4504	VB-4504X-B	1/4HEX
	VB-4504XB-CE	1/4HEX
VBH-1820	VBH-1820X-B	1/4HEX
VBH-3012	VBH-3012X-B	1/4HEX

Push-to-Start

VB-1510PS	VB-1510PS-B	H4
	VB-1510PSX5-B	H5 and 5HEX
	VB-1510PSX-B	1/4HEX
VB-1510PS-18	VB-1510PSX-B-CE	1/4HEX
	VB-1510PS-18-B	H4
	VB-1510PSX5-18B	H5 and 5HEX
VB-1820PS	VB-1510PSX-18-B	1/4HEX
	VB-1510PSX18BCE	1/4HEX
	VB-1820PS-B	H5 and 5HEX
VB-3012PS	VB-1820PSX-B	1/4HEX
	VB-1820PSXB-CE	1/4HEX
VB-4504PS	VB-3012PS-B	H5 and 5HEX
	VB-3012PSX-B	1/4HEX
	VB-3012PSXB-CE	1/4HEX
VBH-1820PS	VB-4504PSX-B	1/4HEX
	VB-4504PSXB-CE	1/4HEX
	VB-4504PSX-B-S	1/4HEX
VBH-3012PS	VB-4504PSXBCE-S	1/4HEX
	VBH-1820PSX-B	1/4HEX
VBH-3012PS	VBH-3012PSX-B	1/4HEX

VZ (100V) P.27

Model	Order Code	Bit Drive
-------	------------	-----------

Lever Start

VZ-1510	VZ-1510	H4
	VZ-1510X5	5HEX
	VZ-1510X	1/4HEX
VZ-1820	VZ-1820	H5 and 5HEX
	VZ-1820X	1/4HEX
VZ-3007	VZ-3007	H5 and 5HEX
	VZ-3007X	1/4HEX
VZ-3012	VZ-3012	H5 and 5HEX
	VZ-3012X	1/4HEX
VZH-1820	VZH-1820X	1/4HEX
VZH-3012	VZH-3012X	1/4HEX

Push-to-Start

VZ-1510PS	VZ-1510PS	H4
	VZ-1510PSX5	5HEX
	VZ-1510PSX	1/4HEX
VZ-1820PS	VZ-1820PS	H5 and 5HEX
	VZ-1820PSX	1/4HEX

Order Codes

Model	Order Code	Bit Drive
VZ-3007PS	VZ-3007PS	H5 and 5HEX
	VZ-3007PSX	1/4HEX
VZ-3012PS	VZ-3012PS	H5 and 5HEX
	VZ-3012PSX	1/4HEX
VZ-4506PS	VZ-4506PSX-S	1/4HEX
VZH-1820PS	VZH-1820PSX	1/4HEX
VZH-3012PS	VZH-3012PSX	1/4HEX

VZ (100V) Variations P.28

For 120V and 220-240V, please contact the HIOS distributor.

Q Suctions

VZQ has a suction attachment as standard, but doesn't include a mouthpiece and a bit. Please select them on P. 51 before ordering.

Model	Order Code	Bit Drive
Lever Start		
VZQ-1510	VZQ-1510	H4
VZQ-1820	VZQ-1820	H5 and 5HEX
VZQ-3007	VZQ-3007	H5 and 5HEX
VZQ-3012	VZQ-3012	H5 and 5HEX

Push-to-Start

VZQ-1510PS	VZQ-1510PS	H4
VZQ-1820PS	VZQ-1820PS	H5 and 5HEX
VZQ-3007PS	VZQ-3007PS	H5 and 5HEX
VZQ-3012PS	VZQ-3012PS	H5 and 5HEX

OPC Screwdrivers Supporting Screw Counters

Model	Order Code	Bit Drive
Lever Start		
VZ-1510-OPC	VZ-1510-OPC	H4
	VZ-1510X5-OPC	5HEX
	VZ-1510X-OPC	1/4HEX
VZ-1820-OPC	VZ-1820-OPC	H5 and 5HEX
	VZ-1820X-OPC	1/4HEX
VZ-3007-OPC	VZ-3007-OPC	H5 and 5HEX
	VZ-3007X-OPC	1/4HEX
VZ-3012-OPC	VZ-3012-OPC	H5 and 5HEX
	VZ-3012X-OPC	1/4HEX
VZH-1820-OPC	VZH-1820X-OPC	1/4HEX
VZH-3012-OPC	VZH-3012X-OPC	1/4HEX

Push-to-Start

VZ-1510PS-OPC	VZ-1510PS-OPC	H4
	VZ-1510PSX5-OPC	5HEX
	VZ-1510PSX-OPC	1/4HEX
VZ-1820PS-OPC	VZ-1820PS-OPC	H5 and 5HEX
	VZ-1820PSX-OPC	1/4HEX
VZ-3007PS-OPC	VZ-3007PS-OPC	H5 and 5HEX
	VZ-3007PSX-OPC	1/4HEX
VZ-3012PS-OPC	VZ-3012PS-OPC	H5 and 5HEX
	VZ-3012PSX-OPC	1/4HEX
VZ-4506PS-OPC	VZ-4506PSXOPC-S	1/4HEX
VZH-1820PS-OPC	VZH-1820PSX-OPC	1/4HEX
VZH-3012PS-OPC	VZH-3012PSX-OPC	1/4HEX

VZ Accessories P.28

Order Code	Applicable Model
------------	------------------

Pistol Attachment

PA-18	VZ Series: Lever start type*3
PA-18PS	VZ Series: Push start type*3

Angle Attachment

ANGLV-Z-CH1*1	VZ Series: Lever start type*3
ANGLV-Z-XX1*2	VZ Series: Lever start type*3

PS Front Cover Ring

VZ18-0960	VZ Series: Push start type*3
-----------	------------------------------

Protective Cover for Torque Adjustment Nut

VZ18-0970	VZ Series*3
-----------	-------------

Shockless Stand

VZ18PS-SAS	VZ Series: Push start type*3
------------	------------------------------

*1 Applicable to HIOS Shank H5 and 5HEX.

*2 Applicable to Hexagonal Shank 1/4HEX.

*3 Except VZ-1510/VZ-4506 Series.

VZ (120V) P.29

Model	Order Code	Bit Drive
-------	------------	-----------

Lever Start

VZ-1820	VZ-1820-120	H5 and 5HEX
	VZ-1820X-120	1/4HEX
VZ-3012	VZ-3012-120	H5 and 5HEX
	VZ-3012X-120	1/4HEX
VZ-4506	VB-4506X-120	1/4HEX
VZH-1820	VZH-1820X-120	1/4HEX
VZH-3012	VZH-3012X-120	1/4HEX

Push-to-start

VZ-1820PS	VZ-1820PS-120	H5 and 5HEX
	VZ-1820PSX-120	1/4HEX
VZ-3012PS	VZ-3012PS-120	H5 and 5HEX
	VZ-3012PSX-120	1/4HEX
VZ-4506PS	VZ-4506PSX-120-S	1/4HEX
VZH-1820PS	VZH-1820PSX-120	1/4HEX
VZH-3012PS	VZH-3012PSX-120	1/4HEX

VZ (220-240V) P.29

Model	Order Code	Bit Drive
-------	------------	-----------

Lever Start

VZ-1812	VZ-1812-B	H5 and 5HEX
	VZ-1812X-B	1/4HEX
VZ-3007	VZ-3007-B	H5 and 5HEX
	VZ-3007X-B	1/4HEX
VZ-4504	VZ-4504X-B	1/4HEX

Push-to-Start

VZ-1812PS	VZ-1812PS-B	H5 and 5HEX
	VZ-1812PSX-B	1/4HEX
VZ-3007PS	VZ-3007PS-B	H5 and 5HEX
	VZ-3007PSX-B	1/4HEX
VZ-4504PS	VZ-4504PSX-B	1/4HEX

PGF P.31

Model	Order Code	Bit Drive
PGF-3000	PGF-3000	H4
PGF-5000	PGF-5000	H4
PGF-7000	PGF-7000	H5 and 5HEX
	PGF-7000X	1/4HEX

Control Unit (for Judgment)

PG-01	PG-01	—
-------	-------	---

Relay Box

PGF-SUBBOX	PGF-SUBBOX	—
------------	------------	---

Screwdriver Cord

3m (10m)	BLF7-0612-VI	—
----------	--------------	---

Damper Unit

BLF-DP	BLF-DP	—
--------	--------	---

Controllers (BLT-AY-61/BLT-AY-71) See P.63

PGF Variations P.32

Q Suction

PGFQ

PGFQ has a suction attachment as standard, but doesn't include a mouthpiece and a bit. Please select them on P. 51 before ordering.

Model	Order Code	Bit Drive
PGFQ-3000	PGFQ-3000	H4
PGFQ-5000	PGFQ-5000	H4
PGFQ-7000	PGFQ-7000	H5

PGFR Suction (Special Order)

PGFR has a suction attachment as standard, but doesn't include a mouthpiece and a bit. Please select them on P. 53 before ordering.

Model	Order Code	Bit Drive
PGFR-5000	PGFR-5000	Screw Type $\varnothing 4$
PGFR-7000	PGFR-7000	Screw Type $\varnothing 4$

•For PGFR Model, please contact the HIOS distributor before ordering.

•PGFR does not include a tube. Please purchase a commercially available tube. Tube shape: inner diameter $\varnothing 4$ x outer diameter $\varnothing 6$.

BLF P.33

Model	Order Code	Bit Drive
BLF-2000	BLF-2000	H4
BLF-5000	BLF-5000	H5 and 5HEX
BLF-7000	BLF-7000	H5
BLF-7000X	BLF-7000X	1/4HEX
BLF-7025X	BLF-7025X	1/4HEX

Screwdriver Cord

3m (10m)	BLF7-0612-VI	—
----------	--------------	---

Damper Unit

BLF-DP	BLF-DP	—
--------	--------	---

Controllers (BLT-AY-61/BLT-AY-71) See P.63

BLF Variations P.34

Q Suction

BLFQ

BLFQ has a suction attachment as standard, but doesn't include a mouthpiece and a bit. Please select them on P. 51 before ordering.

Model	Order Code	Bit Drive
BLFQ-2000	BLFQ-2000	H4
BLFQ-5000	BLFQ-5000	H5
BLFQ-7000	BLFQ-7000	H5

BLFR Suction (Special Order)

BLFR has a suction attachment as standard, but doesn't include a mouthpiece and a bit. Please select them on P. 53 before ordering.

Model	Order Code	Bit Drive
BLFR-5000	BLFR-5000	Screw Type $\varnothing 4$
BLFR-7000X	BLFR-7000X	Screw Type $\varnothing 4$
BLFR-7025X	BLFR-7025X	Screw Type $\varnothing 4$

*For BLFR Model, please contact the HIOS distributor before ordering.

*BLFR does not include a tube. Please purchase a commercially available tube. Tube shape: inner diameter $\varnothing 4 \times$ outer diameter $\varnothing 6$.

CLF / α F / CL-A P.35

HH: HIOS Shank + HIOS Power Supply
XH: HEX Shank + HIOS Power Supply

Model	Order Code	Bit Drive
CLF-3000	CLF-3000HH	H4
CLF-4000	CLF-4000HH	H4
	CLF-4000XH	1/4HEX
CLF-6000	CLF-6000HH	H5
	CLF-6000XH	1/4HEX
CLF-6500	CLF-6500HH	H5
	CLF-6500XH	1/4HEX
CLF-7000	CLF-7000HH	H5
	CLF-7000XH	1/4HEX
α F-4500	α F-4500HH	H4
	α F-4500XH	1/4HEX
α F-4500	α F-4500HH	H4
	α F-4500XH	1/4HEX
α F-5000	α F-5000HH	H4
	α F-5000XH	1/4HEX
α F-6500	α F-6500HH	H5
	α F-6500XH	1/4HEX
CL-816A	CL-816AXH	1/4HEX
	CL-816AXN	1/4HEX
CL-825A	CL-825AXH	1/4HEX
	CL-825AXN	1/4HEX
CL-850A	CL-850AXH	1/4HEX
	CL-850AXN	1/4HEX

For HN (HIOS Shank + Power Supply by Nitto Seiko) and XN (HEX Shank + Power Supply by Nitto Seiko), please contact the HIOS distributor. For CL-816A, CL-825A and CL-850A, XN is available in this catalog.

CLF / α F / CL-A Variations P.36

Model	Order Code	Bit Drive
-------	------------	-----------

Q Suctions

CLFQ and α FQ has a suction attachment as standard, but doesn't include a mouthpiece and a bit. Please select them on P. 51 before ordering.

CLFQ-3000	CLFQ-3000HH	H4
CLFQ-4000	CLFQ-4000HH	H4
CLFQ-6000	CLFQ-6000HH	H5
CLFQ-6500	CLFQ-6500HH	H5
CLFQ-7000	CLFQ-7000HH	H5
α FQ-4500	α FQ-4500HH	H4
α FQ-5000	α FQ-5000HH	H4
α FQ-6500	α FQ-6500HH	H5

CLF/ α F/CL-A Accessories P.35

Model	Order Code	Note
-------	------------	------

Carbon Brush

CLF-3000	A45-0420	—
CLF-4000	CL4-0420	—
α F-4500	A45-0420	—
α F-5000	CL4-0420	—
CLF-6000	CL65-0490	—
CLF-6500	CL65-0490	—
CLF-7000	CL65-0490	—
α F-6500	CL65-0490	—
CL-816A*	CL9-0410	—
CL-825A*	CL9-0410	—
CL-850A	CL850-0381	—

* Please note that the old types of CL-816A and CL-825A have internal carbon whose brush cannot be replaced. If you have any questions, please contact the HIOS distributor.

Recipro RN53 P.37

Model	Order Code	Screwdriver
RN53-200	RN53-200	RD-4000
RN53-260	RN53-260	RD-4500

AC100V (Plug A)

RN53-300	RN53-300*	RD-10 or RD-15
RN53-400	RN53-400*	RD-20 or RD-30

* Please note that for AC-Type Recipro Screwdrivers, HIOS will prepare the components after the screwdriver is specified by the customer.

Controllers

Model	Order Code	Note
RDT-30	RDT-30NIT	DC Type
RAC-100	RAC-100NIT	AC100V

Carbon Brushes

RD-4000	CL4-0420	—
RD-4500	A45-0420	—
RD-10	ACL10-0490	—
RD-15	ACL10-0490	—
RD-20	ACL20-0490	—
RD-30	ACL20-0490	—

Peripherals and Accessories P.39-40

Model	Order Code	Applicable Model
-------	------------	------------------

Screwdriver Cords

1.5m (5P)	CL4-0611	BLG-4000, BLG-5000 Series, BL-3000, BL-5000 Series, CL-2000, CL-3000, CL-4000
2m (5P)	CL65-0660	BL-7000 Series, CL-6000, CL-6500, CL-7000
2m (6P)	RP50-CL	PG, BLG-BC2, BLG-BC1, BLG-ZERO1, BLG-OPC, BL-OPC
3m (5P)	CLF65-0620	HH & XH of CLF-3000, 4000, 6000, 6500, 7000 and α F-6500 for automated machines

Flexible Screwdriver Cords

2m (5P)	CL4-0611H-5P-2	BLG, BL, CL
3m (6P)	CL4-0610H-6P-3	BC2, BC1, ZERO1, BLG-OPC, BL-OPC

Curled Screwdriver Cord

7.5m (5P)	CL65-0660-7.5	BL, CL
-----------	---------------	--------

Curled Screwdriver Cord

3m (5P)	EXTCD-5P3M	BLG, BL, CL
5m (5P)	EXTCD-5P5M	BLG, BL, CL

Model	Order Code	Plug
-------	------------	------

Vacuum Pump

VP-3	VP-3	A-1 (100V)
	VP-3-120USA	A-2 (120V)
	VP-3-220RCH	S (220-240V)
	VP-3-TH	A-3 (220-240V)
	VP-3-230HK	C (220-240V)
	VP-3-230SP	BF (220-240V)

Model	Order Code	Screw Size
-------	------------	------------

HIOS Spike Bits [Yellow]

SPK-1214	SPK-1214	M1.2-1.4
----------	----------	----------

HIOS Spike Bits [Blue]

SPK-1417	SPK-1417	M1.4-1.7
----------	----------	----------

HIOS Spike Bits [Red]

SPK-1720	SPK-1720	M1.7-2.0
----------	----------	----------

HIOS Spike Bits 3-piece Set

SPK-SET01	SPK-SET01	A set of yellow, blue and red bits
-----------	-----------	------------------------------------

Model	Order Code	Bit Drive
-------	------------	-----------

Aluminum Screwdrivers for Watches

WOOD-4AL	WOOD-4AL	Applicable to HIOS H4.
----------	----------	------------------------

Wood Handle

WOOD-5	WOOD-5	Applicable to HIOS H5.
--------	--------	------------------------

Order Codes

Model	Order Code	Note
-------	------------	------

Grip Ring [Red]

GRIP-R10	GRIP-R10	10 pieces per pack
----------	----------	--------------------

Grip Ring [Green]

GRIP-G10	GRIP-G10	10 pieces per pack
----------	----------	--------------------

Grip Ring [White]

GRIP-W10	GRIP-W10	10 pieces per pack
----------	----------	--------------------

Grip Ring [Blue]

GRIP-BL10	GRIP-BL10	10 pieces per pack
-----------	-----------	--------------------

Grip Ring [Yellow]

GRIP-Y10	GRIP-Y10	10 pieces per pack
----------	----------	--------------------

Model	Order Code
-------	------------

Carbon Brushes (2 pcs per pack)

DC Type

CL-3000	A45-0420
CL-4000	CL4-0420
CL-6000	CL65-0490
CL-6500	CL65-0490
CL-7000	CL65-0490
CL-9000	CL9-0410

AC Type

VZ-1510	ACL10-0490
VZ-1820	VZ18-0480
VZ-3007	VZ18-0480
VZ-3012	VZ18-0480
VZ-4506	VZ18-0480
VZ-1812	VZ18-0480
VZ-3007	VZ18-0480
VZ-4504	VZ18-0480

Model	Order Code	Applicable Model
-------	------------	------------------

Vertical Screwdriver Operating Stands

VMS-40	VMS-40	BC2, BC1, ZERO1, BLG, BL, CL, VZ-1510
VMS-50	VMS-50	BC2, BC1, ZERO1, PG, BLG, BL, CL, VZ-1510
VMS-50VZ	VMS-50VZ	VB, PG, VZ (Except VZ-1510)

Please purchase a screwdriver holder if you use PG, BLG-BC2, BLG-BC1, BLG-ZERO1, BLG, BL-7000, VB, VZ-1510 or VZ-1510PS.

VMS Screwdriver Holders

Model	Order Code
-------	------------

PG

PG-3000	VMS-0900-PG3
PG-5000	VMS-3910-PG5
PG-7000	VMS-0900-PG7

BLG-BC2

BLG-4000BC2	VMS-0900-BLG45
BLG-5000BC2	VMS-0900-BLG45

Model	Order Code
-------	------------

BLG-BC1

BLG-4000BC1	VMS-0900-BLG45
-------------	----------------

BLG-5000BC1	VMS-0900-BLG45
-------------	----------------

BLG-ZERO1

BLG-4000ZERO1	VMS-0900-BLG45
---------------	----------------

BLG-5000ZERO1	VMS-0900-BLG45
---------------	----------------

BLG

BLG-4000	VMS-0900-BLG45
----------	----------------

BLG-5000	VMS-0900-BLG45
----------	----------------

BL

BL-7000	VMS-0900-BL7
---------	--------------

VB

VB-1510	VMS-0910-PG5
---------	--------------

VB-1510PS	VMS-0910-PG5
-----------	--------------

VB-1820	VMS-0900-PG7
---------	--------------

VB-3012	VMS-0900-PG7
---------	--------------

VB-1820PS	VMS-0900-VB18PS
-----------	-----------------

VB-3012PS	VMS-0900-VB18PS
-----------	-----------------

VZ

VZ-1510	VMS50-0190
---------	------------

VZ-1510PS	VMS50-0190
-----------	------------

VMS-40/VMS-50: standard	VMS40-0180
-------------------------	------------

VMS-50VZ: standard	VMS-0900-VZ18
--------------------	---------------

Model	Order Code	Applicable Model
-------	------------	------------------

Relay Boxes

BLOP-AF	BLOP-AF	BLG-4000-OPC, BLG-5000 Series-OPC, BL-2000-OPC, BL-3000-OPC, BL-5000 Series-OPC
---------	---------	---

BLOP-OST2	BLOP-OST2	
-----------	-----------	--

STC3

P.41

Model	Order Code	Plug
-------	------------	------

Power Supplies with Screw Counters (DC Type)

BLOP-STC3	BLOP-STC3	A-1 (100V)
	BLOP-STC-3USA	A-2 (120V)
	BLOP-STC-3TH	A-3 (220-240V)
	BLOP-STC-3EUHK	C (220-240V)
	BLOP-STC-3UKSP	BF (220-240V)
CLT-70STC3	BLOP-STC-3-CN	S (220-240V)
	CLT-70STC3	A-1 (100V)
	CLT-70STC3-USA	A-2 (120V)
	CLT-70STC3-TH	A-3 (220-240V)
	CLT-70STC3-EUHK	C (220-240V)
CLT-70STC3	CLT-70STC3-EUHK	C (220-240V)
	CLT-70STC3-UKSP	BF (220-240V)
	CLT-70STC3-CN	S (220-240V)

Power Supplies with Screw Counter (AC Type)

VZOP-STC	VZOP-STC	A-1 (100V)
	VZOP-STC-120	A-2 (120V)

SC1 P.41

Model	Order Code	Applicable Model
-------	------------	------------------

Separate Screw Counter SC1

BLOP-SC1	BLOP-SC1	BC2, BC1, ZERO1, BLG-OPC, BL-OPC
CLOP-SC1	CLOP-SC1	CL

Torque Meters P.43-46

[Measuring] -A2: N-m/lbf-in, -A3: N-m/kgf-cm, -C1: N-m/N-cm, -C2: N-m/lbf-in, -C3: N-m/kgf-cm, -D: kgf-cm/lbf-in

Model	Order Code	Note
-------	------------	------

HP

HP-1	available on request	—
HP-10 (120V)	HPN-10-A2	HIOS
	HPN-10X-A2	HEX
	HPN-10-A3	HIOS
HP-10 (220-240V)	HPN-10X-A3	HEX
	HPN-10-C1	HIOS
	HPN-10X-C1	HEX
	HPN-10-C2	HIOS
	HPN-10X-C2	HEX
	HPN-10-C3	HIOS
	HPN-10X-C3	HEX
HP-100 (120V)	HPN-10-D	HIOS
	HPN-10X-D	HEX
	HPN-100-A2	HIOS
HP-100 (220-240V)	HPN-100X-A2	HEX
	HPN-100-A3	HIOS
	HPN-100X-A3	HEX
HP-100 (220-240V)	HPN-100-C1	HIOS
	HPN-100X-C1	HEX
	HPN-100-C2	HIOS
	HPN-100X-C2	HEX
	HPN-100-C3	HIOS
	HPN-100X-C3	HEX
	HPN-100-D	HIOS
HPN-100X-D	HEX	

HDP

HDP-5 (120V)	HDPN-5-A2	HIOS
	HDPN-5X-A2	HEX
	HDPN-5-A3	HIOS
HDP-5 (220-240V)	HDPN-5X-A3	HEX
	HDPN-5-C1	HIOS
	HDPN-5X-C1	HEX
HDP-5 (220-240V)	HDPN-5-C2	HIOS
	HDPN-5X-C2	HEX
	HDPN-5-C3	HIOS
	HDPN-5X-C3	HEX
	HDPN-5-D	HIOS
	HDPN-5X-D	HEX
	HDP-50 (120V)	HDPN-50-A2
HDPN-50X-A2		HEX
HDPN-50-A3		HIOS
HDP-50 (120V)	HDPN-50X-A3	HEX

Model	Order Code	Note
HDP-50 (220-240V)	HDPN-50-C1	HIOS
	HDPN-50X-C1	HEX
	HDPN-50-C2	HIOS
	HDPN-50X-C2	HEX
	HDPN-50-C3	HIOS
	HDPN-50X-C3	HEX
	HDPN-50-D	HIOS
	HDPN-50X-D	HEX
HDP-100 (100V)	HDPN-100X	HEX
HDP-100 (120V)	HDPN-100X-A2	HEX
	HDPN-100X-A3	HEX
HDP-100 (220-240V)	HDPN-100X-C1	HEX
	HDPN-100X-C2	HEX
	HDPN-100X-C3	HEX
	HDPN-100X-D	HEX

HM

HM-10	HM-10	100V
	HM-10-120	120V
	HM-10-230B	220-240V BF Plug
HM-100	HM-10-230G	220-240V C Plug
	HM-100	100V
	HM-100-120	120V
	HM-100-230B	220-240V BF Plug
	HM-100-230G	220-240V C Plug

HIT

HIT-200	HIT-200	100V
	HIT-200-120	120V
	HIT-200-220B	220-240V BF Plug
	HIT-200-220G	220-240V C Plug
HIT-500	HIT-500	100V
	HIT-500-120	120V
	HIT-500-220B	220-240V BF Plug
	HIT-500-220G	220-240V C Plug
HIT-2000	HIT-2000	100V
	HIT-2000-120	120V
	HIT-2000-220B	220-240V BF Plug
	HIT-2000-220G	220-240V C Plug

The measuring jig for HP-1 should be prepared by the customer.

For details of HP-1 accessories, please contact the HIOS distributor.

Torque Meters Accessories P.43-46

HP Accessories

Order Code	Meas. range N-m	Note
HP-10 Fidaptor		
TF4G-Z	0.15-0.6	H4
TF65G-Z*2	0.15-0.6	—
TF45G-Z	0.25 or smaller	H4
TF45-Z*1	0.25 or smaller	H4

HP-100 Fidaptor

TF5G-Z	0.5-3	H5
TF6XG-Z*2	0.5-3	—
TF6UP-Z*1	3-9	1/4HEX
TF6U-Z*1	3-9	1/4HEX

Order Code	Meas. range N-m	Note
HP-100 Shaft with a Screw		
TF6XG-0010*2	—	—
TF5G-0010-4	—	H4

Buffer Spring

CL65-0040	0.15-0.6	—
-----------	----------	---

Grease

TF-G3	—	—
-------	---	---

*1 This type has no safety cover.

*2 HEX Shank with 2 steps: (upper) 5HEX, (lower) 1/4HEX.

HDP Accessories

Order Code	Meas. range N-m	Note
Detector Cord		
DPC-0506	—	—

HM Accessories

Order Code	Meas. range N-m	Note
HM-10 Fidaptor		
TFM26-Z	0.15-0.6	+#1
TFM20-Z	0.25 or smaller	+#0

HM-100 Fidaptor

TFM40-Z	0.5-3	+#2
---------	-------	-----

Buffer Spring

CL65-0040	0.15-0.6	—
-----------	----------	---

HIT Accessories

Order Code	Meas. range N-m	Note
Detector Cord		
DPC-0506	—	—

HP/HDP Battery Chargers

Order Code	Meas. range N-m	Plug Shape
TCH-MULTI	100-240V	A Plug
TCH-MULTI-CN	100-240V	A Plug (CQC)
TCH-MULTI-CE	100-240V	C Plug

	P/N: TCH-MULTI Certifications:  Japan, US, Canada, Mexico, Taiwan, Southeast Asia (1) (Thailand and Philippines)
	P/N: TCH-MULTI-CN Certifications:  China

	P/N: TCH-MULTI-CE Certifications:  Southeast Asia (2) (Vietnam, Indonesia, India, Singapore, Malaysia, Korea and Hong Kong)
---	---

For countries not listed above, please inquire at the HIOS distributor.

HM/HIT Battery Chargers

Order Code	Voltage	Plug Shape
TCH-100N	AC100V	A Plug
TCH-120N	AC110-120V	A Plug
TCH-230G	AC220-240V	C Plug
TCH-230B	AC220-240V	BF Plug

	P/N: TCH-100N Certifications:  Japan
	P/N: TCH-120N Certifications:  Taiwan, US, Canada and Mexico

	P/N: TCH-230G Certifications:  Hong Kong and China
---	--

	P/N: TCH-230B Certifications:  Singapore, UK and Ireland
---	--

Screw Feeders P.47-48

For Manual Operation

Model	Order Code	Nominal dia.
HSV		
HSV-10	HSV-10	M1.0
HSV-12	HSV-12	M1.2
HSV-14	HSV-14	M1.4
HSV-17	HSV-17	M1.7
HSV-20	HSV-20	M2.0
HSV-23	HSV-23	M2.3
HSV-26	HSV-26	M2.6
HSV-30	HSV-30	M3.0
HS		
HS-35	HS-35-EC	M3.5
HS-40	HS-40-EC	M4.0
HS-50	HS-50-EC	M5.0
HSIII		
HSIII-10	HS-10-3-EC	M1.0
HSIII-12	HS-12-3-EC	M1.2
HSIII-14	HS-14-3-EC	M1.4
HSIII-17	HS-17-3-EC	M1.7
HSIII-20	HS-20-3-EC	M2.0
HSIII-23	HS-23-3-EC	M2.3
HSIII-26	HS-26-3-EC	M2.6
HSIII-30	HS-30-3-EC	M3.0
HSF		
HSF-10	HSF-10	M1.0
HSF-12	HSF-12	M1.2
HSF-14	HSF-14	M1.4
HSF-17	HSF-17	M1.7
HSF-20	HSF-20	M2.0

Order Codes

Model	Order Code	Nominal dia.
HSF-23	HSF-23	M2.3
HSF-26	HSF-26	M2.6
HSF-30	HSF-30	M2.6

For Automated Machines

Model	Order Code	Nominal dia.
-------	------------	--------------

HSV-RB

HSV-10RB	HSV-10RB	M1.0
HSV-12RB	HSV-12RB	M1.2
HSV-14RB	HSV-14RB	M1.4
HSV-17RB	HSV-17RB	M1.7
HSV-20RB	HSV-20RB	M2.0
HSV-23RB	HSV-23RB	M2.3
HSV-26RB	HSV-26RB	M2.6
HSV-30RB	HSV-30RB	M3.0

HS-RB

HS-35RB	HS-35RB-EC	M3.5
HS-40RB	HS-40RB-EC	M4.0
HS-50RB	HS-50RB-EC	M5.0

HSIII-RB

HSIII-14RB	HS-14-3RB-EC	M1.4
HSIII-17RB	HS-17-3RB-EC	M1.7
HSIII-20RB	HS-20-3RB-EC	M2.0
HSIII-23RB	HS-23-3RB-EC	M2.3
HSIII-26RB	HS-26-3RB-EC	M2.6
HSIII-30RB	HS-30-3RB-EC	M3.0

For a screw feeder with overseas specifications, please inquire at the HIOS distributor.

Screw Accessories P.47-48

Replacement Rails for Manual Operation

Order Code	Nominal dia.
------------	--------------

HSV

HSV-BI-10	M1.0
HSV-BI-12	M1.2
HSV-BI-14	M1.4
HSV-BI-17	M1.7
HSV-BI-20	M2.0
HSV-BI-23	M2.3
HSV-BI-26	M2.6
HSV-BI-30	M3.0

HS

HS-R35	M3.5
HS-R40	M4.0
HS-R50	M5.0

HSIII

HS-SR10	M1.0
HS-SR12	M1.2
HS-SR14	M1.4
HS-SR17	M1.7
HS-SR20	M2.0
HS-SR23	M2.3
HS-SR26	M2.6
HS-SR30	M3.0

HSF

HS-WR10	M1.0
HS-WR12	M1.2

Model	Order Code	Nominal dia.
HS-WR14	M1.4	
HS-WR17	M1.7	
HS-WR20	M2.0	
HS-WR23	M2.3	
HS-WR26	M2.6	
HS-WR30	M3.0	

Replacement rail for Automated Machines

Order Code	Nominal dia.
------------	--------------

HSV-RB

HSV-RI-10	M1.0
HSV-RI-12	M1.2
HSV-RI-14	M1.4
HSV-RI-17	M1.7
HSV-RI-20	M2.0
HSV-RI-23	M2.3
HSV-RI-26	M2.6
HSV-RI-30	M3.0

HS-RB

HS-R35RB	M3.5
HS-R40RB	M4.0
HS-R50RB	M5.0

HSIII-RB

HS-SR14RB	M1.4
HS-SR17RB	M1.7
HS-SR20RB	M2.0
HS-SR23RB	M2.3
HS-SR26RB	M2.6
HS-SR30RB	M3.0

AC Adaptors

The AC adapter is now common to all models. The old type will be unavailable when our stock runs out. Also, the new type is not compatible with the old type. Please be careful about this when ordering.

Order Code	Voltage	Plug Shape
------------	---------	------------

New Type

All Models

HSV-AD-PSE	AC100-240V	A Plug
------------	------------	--------

Old Type

HS/HSIII

HSV-AD	AC100V	A Plug
--------	--------	--------

HSF

HSF-AD	AC100-240V	A Plug
--------	------------	--------

HSV

HSV-AD-PSE*	AC100-240V	A Plug
-------------	------------	--------

* The HSV Series is already compatible with the new type.

HS/HSIII

HSV-AD*	AC100V	A Plug
---------	--------	--------

HSV

HSV-AD-PSE	AC100-240V	A Plug
HSV-AD-CN	AC100-240V	A Plug (CCC)
HSV-AD-EUHK	AC100-240V	C Plug
HSV-AD-UL	AC100-240V	A Plug (CCC)

Order Code	Voltage	Plug Shape
HSV-AD-KC	AC100-240V	C Plug

* Please contact the HIOS distributor before ordering. If you order the old type of AC Adaptor for HS and HSIII for EU, you will need HSV-AD-EUHK and the conversion cable (HSV-AD-CONVERSIONCABLE). Please let us know as such.

BL-SB P.49

Model	Order Code	Note
-------	------------	------

Brushless Screwdrivers

BL-5000SB	BL-5000SB	—
BL-7000SB	BL-7000SB	—

Power Supplies (T-45BL / T-70BL) See P.62

SB-C P.49-50

Model	Order Code	Note
-------	------------	------

Brushed Screwdrivers

SB-400C	SB-400C	—
SB-650C	SB-650C	—

Power Supplies (T-45BL) See P.62

Controller

SBC-1	SBC-1	—
-------	-------	---

Carbon Brushes

SB-400C	CL4-0420	—
SB-650C	CL65-0490	—

Suction Attachments for Suction Screwdrivers P.51

Note: The order codes below are for the suction attachments alone. If you want a suction screwdriver, please select the screwdriver body and the suction unit (suction attachment, mouthpiece and bit) on P. 51 before ordering.

Model	Order Code	Bit
-------	------------	-----

Brushless Screwdrivers (DC Type)

BLG-BC2/BLG-BC1/BLG-ZERO1/BLG

BLG-4000 Series	BLGQ4-SET	H4 60mm
BLG-4000BC2-LT	CLQ2-SET	H4 60mm
	CLQ2SET-ESD*	H4 60mm
BLG-5000 Series BLG-5000-15	BLQ5-SET	H4 40mm
	BLQ5-SET-ESD*	H4 40mm
	BLQ5N-SET	H4 60mm
BLG-7000BC2	BLQ5N-SET-ESD*	H4 60mm
	BLQ7-SET	H5 80mm
	BLQ7-SET-ESD	H5 80mm

BL

BL-2000	CLQ2-SET	H4 60mm
	CLQ2-SET-ESD*	H4 60mm
BL-3000	BLQ3N-SET	H4 60mm
	BLQ3N-SET-ESD*	H4 60mm

Model	Order Code	Bit
BL-5000	BLQ5-SET	H4 40mm
	BLQ5-SET-ESD*	H4 40mm
	BLQ5N-SET	H4 60mm
	BLQ5N-SET-ESD*	H4 60mm
BL-7000	BLQ7-SET	H5 80mm
	BLQ7-SET-ESD*	H5 80mm

Brushed Screwdriver (DC Type)

Model	Order Code	Bit
-------	------------	-----

CL

CL-2000	CLQ2-SET	H4 60mm
	CLQ2-SET-ESD*	H4 60mm
CL-3000	CLQ4-SET	H4 60mm
	CLQ4-SET-ESD*	H4 60mm
CL-4000	CLQ4-SET	H4 60mm
	CLQ4-SET-ESD*	H4 60mm
CL-6000	CLQ65-SET	H5 80mm
	CLQ65-SET-ESD*	H5 80mm
CL-6500	CLQ65-SET	H5 80mm
	CLQ65-SET-ESD*	H5 80mm
CL-7000	CLQ65-SET	H5 80mm
	CLQ65-SET-ESD*	H5 80mm

Brushless Screwdrivers (AC Type)

VB

VB-1820	VZQ18-SET	H5 100mm
VB-3012	VZQ18-SET	H5 100mm
VB-3020	VZQ18-SET	H5 100mm

Brushed Screwdrivers (AC Type)

VZ

VZQ-1510	VZQ10-SET	H4 60mm
VZQ-1820	VZQ18-SET	H5 100mm
VZQ-3007	VZQ18-SET	H5 100mm
VZQ-3012	VZQ18-SET	H5 100mm

* Anti-electrostatic types.

Brushless Screwdrivers for Automated Machines (DC Type)

Model	Order Code	Bit & Note
-------	------------	------------

PGF

PGF-3000	PGFQ3-SET	H4 80mm
PGF-5000	PGFQ5-SET	H4 80mm
PGF-7000	PGFQ7-SET	H5 100mm

Model	Order Code	Bit & Note
-------	------------	------------

BLF

BLF-2000	BLFQ2-SET	H4 60mm
BLF-5000	BLFQ5-SET	H5 100mm
BLF-7000	BLFQ7-SET	H5 100mm

Suction Attachments for Screws for Deep Recessed Holes P.53

Note: The order codes below are for the suction attachments alone. If you want a suction screwdriver, please select the screwdriver body and the suction unit (suction attachment, mouthpiece and bit) on P. 51 before ordering.

Model	Order Code
-------	------------

Brushless Screwdrivers for Automated Machines (DC Type)

PGFR (Special Order)

PGF-5000	PGFR5-SA
PGF-7000X	PGFR7-SA

BLFR (Special Order)

BLF-5000	BLFR5-SA
BLF-7000X	BLFR7-SA
BLF-7025X	BLFR7-SA

Plug Types

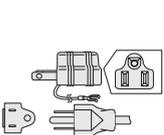
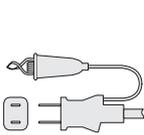
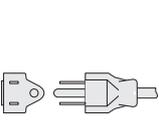
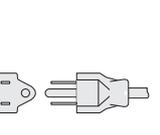
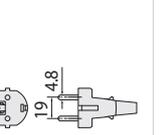
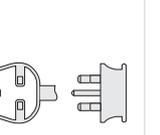
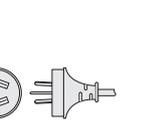
Voltage	100V		120V	220-240V			
	Type A	Type A-1	Type A-2	Type A-3	Type C	Type BF	Type S
Plug Shape							

HIOS Inc.

Head Office: 1-35-1 Oshiage, Sumida-ku Tokyo, Japan 131-0045 Phone: +81 (Japan) 3-6661-8821 FAX: +81 (Japan) 3-6661-8828

Osaka Office: 18F Naniwasuji SIA Bldg., 2-4-2 Shinmachi, Nishi-ku, Osaka City, Japan 550-0013 Phone: +81 (Japan) 6-6533-0903 FAX: +81 (Japan) 6-6534-0609

Nagoya Office: 8F Kirix Marunouchi Bldg., 1-17-19 Marunouchi, Naka-ku, Nagoya, Aichi Pref., Japan 460-0002 Phone: +81 (Japan) 52-219-5566 FAX: +81 (Japan) 52-219-5558

Yamagata Factory: 5 Takagi, Yamagata City, Yamagata Pref., Japan 990-2346 Phone: +81 (Japan) 23-645-8100 FAX: +81 (Japan) 3-645-2546

HIOS (SHENZHEN) Co., LTD.: 10D Room, Seaview Square, No.18. Taizi Road, Shekou Nanshan District, Shenzhen, Guangdong Province, China 518000 Phone: +86 (China) 755-26674278 FAX: +86 (China) 755-26858347

- Please note the specifications and appearance may change as improvements are made.
- Using copies or reproduction of this general catalog without permission is prohibited.
- The information presented in this catalog is current as of January 2022.
- Catalog number: EK-A001



Cautions for Safety

Read the instruction manual carefully before use and operate the screwdriver for its intended purposes.
Always use the specified current and voltage.



<https://hios.com>